

# *Real-Time Clock and Interrupt Module (RCIM) User's Guide*

---



0898007-610  
February 2013

Copyright 2013 by Concurrent Computer Corporation. All rights reserved. This publication or any part thereof is intended for use with Concurrent Computer Corporation products by Concurrent Computer Corporation personnel, customers, and end-users. It may not be reproduced in any form without the written permission of the publisher.

The information contained in this document is believed to be correct at the time of publication. It is subject to change without notice. Concurrent Computer Corporation makes no warranties, expressed or implied, concerning the information contained in this document.

To report an error or comment on a specific portion of the manual, photocopy the page in question and mark the correction or comment on the copy. Mail the copy (and any additional comments) to Concurrent Computer Corporation, 2881 Gateway Drive Pompano Beach, FL 33069. Mark the envelope “**Attention: Real-Time OS Publications Department.**” This publication may not be reproduced for any other reason in any form without written permission of the publisher.

Concurrent Computer Corporation and its logo are registered trademarks of Concurrent Computer Corporation. All other Concurrent product names are trademarks of Concurrent while all other product names are trademarks or registered trademarks of their respective owners. Linux® is used pursuant to a sublicense from the Linux Mark Institute.

Printed in U. S. A.

Revision History:	Level:	Effective With:
Original Release -- August 2002	000	RedHawk Linux Release 1.1
Previous Release -- December 2003	210	RedHawk Linux Release 2.0
Current Release -- May 2005	300	RedHawk Linux Release 2.3
Update -- September 2005	310	RedHawk Linux Release 2.3-4.1
Update -- May 2007	320	RedHawk Linux Release 4.2
Update -- April 2008	330	RedHawk Linux Release 5.1
Update -- June 2008	400	RedHawk Linux Release 5.1
Update -- October 2010	500	RedHawk Linux Release 5.4
Update -- December 2011	600	RedHawk Linux Release 6.0
Update -- February 2013	610	RedHawk Linux Release 6.3

## Scope of Manual

This manual is intended for users responsible for the installation and use of the Real-Time Clock and Interrupt Module (RCIM) on Concurrent Computer Corporation's iHawk™ systems under the RedHawk™ Linux® operating system.

### NOTE

Three RCIM models are described in this guide: RCIM I, RCIM II and RCIM III. The use of the term "RCIM" refers to functionality common to all three boards. "RCIM I", "RCIM II" and "RCIM III" refer to the specific boards. Refer to the section "Specifications" on page 1-2 for specifications for each of the boards.

## Structure of Manual

This manual consists of the following:

- Chapter 1, *Introduction*, contains a general overview and specifications for the RCIM boards.
- Chapter 2, *Hardware, Installation and Configuration*, provides a description of the RCIM boards and connectors, as well as installation and configuration instructions.
- Chapter 3, *Functional Description*, provides the general operation, user interfaces and configuration options for the clocks and interrupts available on the RCIM.
- Appendix A, *Registers*, describes the RCIM registers.
- Appendix B, *Calculating RCIM Cable Propagation Delays*, provides a formula for guarding against propagation delay when chaining RCIMs.
- The *Index* contains an alphabetical reference to key terms and concepts and the pages where they occur in the text.

## Syntax Notation

The following notation is used throughout this guide:

- |                  |  |
|------------------|--|
| <i>italic</i>    | Books, reference cards, and items that the user must specify appear in <i>italic</i> type. Special terms may also appear in <i>italic</i> .  |
| <b>list bold</b> | User input appears in <b>list bold</b> type and must be entered exactly as shown. Names of directories, files, commands, options and man page references also appear in <b>list bold</b> type. |

- `list` Operating system and program output such as prompts, messages and listings of files and programs appears in `list` type.
- [ ] Brackets enclose command options and arguments that are optional. You do not type the brackets if you choose to specify these options or arguments.
- hypertext links When viewing this document online, clicking on chapter, section, figure, table and page number references will display the corresponding text. Clicking on Internet URLs provided in *blue* type will launch your web browser and display the web site. Clicking on publication names and numbers in *red* type will display the corresponding manual PDF, if accessible.

## Related Publications

Title	Pub No.
<i>RedHawk Linux Release Notes Version x.x</i>	0898003
<i>RedHawk Linux User's Guide</i>	0898004
<i>RedHawk Linux Frequency-Based Scheduler (FBS) User's Guide</i>	0898005
<i>iHawk Optimization Guide</i>	0898011

where *x.x* = release version

# Contents

<b>Preface</b> .....	iii
<b>Chapter 1 Introduction</b>	
Overview .....	1-1
Specifications .....	1-2
<b>Chapter 2 Hardware, Installation and Configuration</b>	
Board Descriptions .....	2-1
RCIM III .....	2-2
Board Illustration .....	2-2
Connectors and LEDs .....	2-3
LED Functions .....	2-3
Input and Output Cables and Connectors .....	2-4
Oscillators .....	2-4
GPS Antenna .....	2-5
External Interrupt I/O Connector .....	2-5
System Identification .....	2-7
Daisy Chain Cable .....	2-7
RCIM II .....	2-8
Board Illustration .....	2-8
Connectors and LEDs .....	2-8
LED Functions .....	2-9
Input and Output Cable Connectors .....	2-10
Oscillators .....	2-10
GPS Antenna .....	2-10
External Interrupt I/O Connector .....	2-10
System Identification .....	2-12
Daisy Chain Cable .....	2-12
RCIM I .....	2-13
Board Illustration .....	2-13
Connectors and LEDs .....	2-14
LED Functions .....	2-14
Output Cable Connector (P2) .....	2-15
Input Cable Connector (P3) .....	2-16
External Interrupts Connector (P4) .....	2-16
Debug Visibility Connector (P5) .....	2-17
In-System Programming Interface Connector (P6) .....	2-17
System Identification .....	2-17
Connection Modes .....	2-18
Unpacking the RCIM .....	2-18
Installation .....	2-19
Configuration .....	2-20
Kernel Configuration .....	2-20
Driver Configuration .....	2-20
Static Configuration .....	2-20
Dynamic Configuration .....	2-21

General Considerations . . . . .	2-22
MSI Interrupt Configuration . . . . .	2-22
ntp Configuration for GPS Support . . . . .	2-23
Verifying ntp/GPS Operation . . . . .	2-23

### Chapter 3 Functional Description

Overview . . . . .	3-1
Clocks. . . . .	3-1
The Tick Clock . . . . .	3-2
The POSIX Clock . . . . .	3-2
Direct Access to the Clocks . . . . .	3-3
Synchronizing the Clocks . . . . .	3-3
The rcim_clocksync Utility . . . . .	3-3
Synchronizing the Tick Clock . . . . .	3-5
RCIM Masterclock Considerations . . . . .	3-5
Synchronizing the POSIX Clock . . . . .	3-5
Automatic Synchronization . . . . .	3-6
Using GPS for System Timekeeping . . . . .	3-6
Interrupt Processing . . . . .	3-8
Interrupt Processing Logic . . . . .	3-8
Arming and Enabling DIs and ETIs . . . . .	3-9
Interrupt Recognition Logic . . . . .	3-9
Setting up Distributed Interrupts . . . . .	3-10
Obtaining RCIM Values . . . . .	3-11
Edge-Triggered Interrupts. . . . .	3-12
ETI Configuration . . . . .	3-12
ETI Device Files . . . . .	3-13
User Interface to ETIs . . . . .	3-13
Distributed ETIs. . . . .	3-14
Real-Time Clocks (RTCs). . . . .	3-14
RTC Device Files. . . . .	3-14
Distributed RTCs . . . . .	3-14
User Interface to RTCs . . . . .	3-15
External Output Interrupts . . . . .	3-15
Configuration. . . . .	3-16
Programmable Interrupt Generators (PIGs) . . . . .	3-16
PIG Device File . . . . .	3-16
Distributed PIGs . . . . .	3-17
Distributed Interrupts . . . . .	3-17
DI Configuration . . . . .	3-18
DI Device Files . . . . .	3-19
User Interface to DIs . . . . .	3-19

### Appendix A Registers

RCIM III Registers. . . . .	A-1
RCIM III Address Map . . . . .	A-1
RCIM III Registers . . . . .	A-3
RCIM II Registers . . . . .	A-21
RCIM II Address Map . . . . .	A-21
RCIM II Registers. . . . .	A-23
RCIM I Registers . . . . .	A-36

RCIM I Address Map . . . . .	A-36
RCIM I Registers . . . . .	A-37

**Appendix B Calculating RCIM Cable Propagation Delays**

RCIM III . . . . .	B-1
RCIM II . . . . .	B-1
RCIM I . . . . .	B-2

<b>Index . . . . .</b>	<b>Index-1</b>
------------------------	----------------

**Illustrations**

Figure 2-1 RCIM III Board . . . . .	2-2
Figure 2-2 RCIM III Connectors and LED Locations . . . . .	2-3
Figure 2-3 RCIM III External Interrupt I/O Connector Pin-outs . . . . .	2-6
Figure 2-4 RCIM II Board . . . . .	2-8
Figure 2-5 RCIM II Connectors and LED Locations . . . . .	2-9
Figure 2-6 RCIM II External Interrupt I/O Connector Pin-outs . . . . .	2-11
Figure 2-7 RCIM I Board . . . . .	2-13
Figure 2-8 RCIM I Connectors and LED Locations . . . . .	2-14
Figure 2-9 RCIM I Output Cable Connector (P2) Pin-outs . . . . .	2-15
Figure 2-10 RCIM I Input Cable Connector (P3) Pin-outs . . . . .	2-16
Figure 2-11 RCIM I External Interrupts Connector (P4) Pin-outs . . . . .	2-17
Figure 3-1 Interrupt Processing Logic . . . . .	3-8
Figure 3-2 Distributed Interrupt Operation Example . . . . .	3-10
Figure A-1 RCIM III Board Status/Control Register (BSCR) . . . . .	A-3
Figure A-2 RCIM III Firmware Revision/Options Present Register (FWOP) . . . . .	A-4
Figure A-3 RCIM III Interrupt Enable/Request/Pending/Clear/Arm/Level/Polarity Registers (IER, IRR, IPR, ICR, IAR, ISLR, ISPR) . . . . .	A-5
Figure A-4 RCIM III External Interrupt Routing Registers (EIRR) . . . . .	A-6
Figure A-5 RCIM III Cable Interrupt Routing Registers (CIRR) . . . . .	A-7
Figure A-6 RCIM III PPS Snapshot Register (PPS) . . . . .	A-8
Figure A-7 RCIM III Cable Snapshot Register (CSR) . . . . .	A-8
Figure A-8 RCIM III Cable Master Time Register (CMTR) . . . . .	A-8
Figure A-9 RCIM III Clear Cable Errors Register (CCERR) . . . . .	A-9
Figure A-10 RCIM III Output Cable Status Register (OCSR) . . . . .	A-9
Figure A-11 RCIM III Input Cable Status Register (ICSR) . . . . .	A-10
Figure A-12 RCIM III Tick Clock Upper Register (TCU) . . . . .	A-10
Figure A-13 RCIM III Tick Clock Lower Register (TCL) . . . . .	A-11
Figure A-14 RCIM III Tick Clock Status/Control Register (TCSC) . . . . .	A-11
Figure A-15 RCIM III POSIX Clock Seconds Register (PCS) . . . . .	A-12
Figure A-16 RCIM III POSIX Clock Nanoseconds Register (PCN) . . . . .	A-12
Figure A-17 RCIM III POSIX Clock Status/Control Register (PCSC) . . . . .	A-13
Figure A-18 RCIM III POSIX Clock Skip/Add Time Register (PCSAT) . . . . .	A-13
Figure A-19 RCIM III Clock Frequency Adjust Register (CFAR) . . . . .	A-14
Figure A-20 RCIM III RTC Timer Registers (RTCT) . . . . .	A-14
Figure A-21 RCIM III RTC Repeat Registers (RTCR) . . . . .	A-14
Figure A-22 RCIM III RTC Control Registers (RTCC) . . . . .	A-15
Figure A-23 RCIM III Programmable Interrupt Generator Register (PIG) . . . . .	A-16
Figure A-24 RCIM III Programmable Interrupt Set/Clear Registers (PIGS, PIGC) . . . . .	A-16
Figure A-25 RCIM III SPI Count Register (SCR) . . . . .	A-17
Figure A-26 RCIM III GPS Receive Pointers (GRXP) . . . . .	A-17

Figure A-27	RCIM III GPS Transmit Pointers (GTXP) . . . . .	A-18
Figure A-28	RCIM III GPS Debug Control Register (GDCR) . . . . .	A-18
Figure A-29	RCIM III GPS Communication Error Register (GCER) . . . . .	A-19
Figure A-30	RCIM III SPI Data Buffer (SDB) . . . . .	A-19
Figure A-31	RCIM III GPS Receive Data Buffer (GRDB) . . . . .	A-19
Figure A-32	RCIM III GPS Transmit Data Buffer (GRDB) . . . . .	A-20
Figure A-33	RCIM II Board Status/Control Register (BSCR) . . . . .	A-23
Figure A-34	RCIM II Firmware Revision/Options Present Register (FWOP) . . . .	A-24
Figure A-35	RCIM II Interrupt Enable/Request/Pending/Clear/Arm/Level/Polarity Registers (IER, IRR, IPR, ICR, IAR, ISLR, ISPR) . . . . .	A-25
Figure A-36	RCIM II External Interrupt Routing Registers (EIRR) . . . . .	A-26
Figure A-37	RCIM II Cable Interrupt Routing Registers (CIRR) . . . . .	A-27
Figure A-38	RCIM II PCI Interrupt Routing Registers (PARR, PBRR, PCRR, PDRR) . . . . .	A-28
Figure A-39	RCIM II DDS Adjust Register (DDS) . . . . .	A-28
Figure A-40	RCIM II PPS Snapshot Register (PPS) . . . . .	A-29
Figure A-41	RCIM II GPS Transmit/Receive Register (GPS) . . . . .	A-29
Figure A-42	RCIM II Clear Cable Errors Register (CCERR) . . . . .	A-29
Figure A-43	RCIM II Tick Clock Upper Register (TCU) . . . . .	A-30
Figure A-44	RCIM II Tick Clock Lower Register (TCL) . . . . .	A-30
Figure A-45	RCIM II Tick Clock Status/Control Register (TCSC) . . . . .	A-30
Figure A-46	RCIM II POSIX Clock Seconds Register (PCS) . . . . .	A-31
Figure A-47	RCIM II POSIX Clock Nanoseconds Register (PCN) . . . . .	A-31
Figure A-48	RCIM II POSIX Clock Status/Control Register (PCSC) . . . . .	A-32
Figure A-49	RCIM II POSIX Clock Skip/Add Time Register (PCSAT) . . . . .	A-32
Figure A-50	RCIM II RTC Timer Registers (RTCT) . . . . .	A-33
Figure A-51	RCIM II RTC Repeat Registers (RTCR) . . . . .	A-33
Figure A-52	RCIM II RTC Control Registers (RTCC) . . . . .	A-34
Figure A-53	RCIM II Programmable Interrupt Generator Register (PIG) . . . . .	A-35
Figure A-54	RCIM II Programmable Interrupt Set/Clear Registers (PIGS, PIGC) . .	A-35
Figure A-55	RCIM I Board Status/Control Register (BSCR) . . . . .	A-37
Figure A-56	RCIM I Interrupt Enable/Request/Pending/Clear/ARM/Level/Polarity Registers (IER, IRR, IPR, ICR, IAR, ISLR, ISPR) . . . . .	A-38
Figure A-57	RCIM I External Interrupt Routing Register (EIRR) . . . . .	A-39
Figure A-58	RCIM I Cable Interrupt Routing Register (CIRR) . . . . .	A-40
Figure A-59	RCIM I Tick Clock Upper Register (TCU) . . . . .	A-41
Figure A-60	RCIM I Tick Clock Lower Register (TCL) . . . . .	A-41
Figure A-61	RCIM I Tick Clock Status/Control Register (TCSC) . . . . .	A-41
Figure A-62	RCIM I POSIX Clock Seconds Register (PCS) . . . . .	A-42
Figure A-63	RCIM I POSIX Clock Nanoseconds Register (PCN) . . . . .	A-42
Figure A-64	RCIM I POSIX Clock Status/Control Register (PCSC) . . . . .	A-42
Figure A-65	RCIM I RTC Control Registers . . . . .	A-43
Figure A-66	RCIM I RTC Timer Registers . . . . .	A-43
Figure A-67	RCIM I Programmable Interrupt Generator Register (PIG) . . . . .	A-44



This chapter provides an overview and specifications for the Real-Time Clock and Interrupt Module (RCIM).

## NOTE

Three RCIM models are described in this guide: RCIM I, RCIM II and RCIM III. The use of the term “RCIM” refers to functionality common to all three boards. “RCIM I”, “RCIM II” and “RCIM III” refer to the specific boards. The section “Specifications” provides specifications for each of the boards.

## Overview

The Real-Time Clock and Interrupt Module (RCIM) is a PCI-based card that supports time-critical applications that require rapid response to external events, synchronized clocks and/or synchronized interrupts.

When RCIM boards of various systems are chained together, an interrupt can be simultaneously distributed to all connected RCIMs, and from the RCIMs to all the associated host systems.

A synchronized high-resolution clock is provided so that all the RCIMs in an RCIM chain on multiple systems can share a common time base. It also provides a local POSIX 1003.1 compliant high resolution clock. An optional GPS module allows alignment of the clock to GPS standard time. A high stability oscillator is standard. Optional oscillators improve the accuracy of times measured with the RCIM.

In addition to the clocks, this multi-purpose PCI-based card has the following functionality:

- connection of external device interrupts
- real time clock timers that can interrupt the system
- programmable interrupt generators which allow generation of an interrupt from an application program

These functions can all generate local interrupts on the system where the RCIM card is installed. When systems are chained together, multiple input and output interrupts can be distributed to other RCIM-connected systems. This allows one timer or one external interrupt or one application program to interrupt multiple RedHawk Linux systems almost simultaneously to create synchronized actions.

# Specifications

Feature	RCIM III	RCIM II	RCIM I
<b>Clocks</b>			
<b>POSIX</b>			
Length	64 bits (two 32-bit words)	64 bits (two 32-bit words)	64 bits (two 32-bit words)
Resolution	High-order 32 bits–1 second Low-order 32 bits–400 nsec	High-order 32 bits–1 second Low-order 32 bits–400 nsec	High-order 32 bits–1 second Low-order 32 bits–400 nsec
Oscillator stability	+/-2.5 PPM	+/-20 PPM	+/-100 PPM
<b>Tick Timer</b>			
Length	64 bits (two 32-bit words)	64 bits (two 32-bit words)	64 bits (two 32-bit words)
Resolution	64 bit counter of 400 ns ticks	64 bit counter of 400 ns ticks	64 bit counter of 400 ns ticks
<b>Real-Time Clocks</b>			
Number	8	8	4
Length	32 bits	32 bits	32 bits
Resolution	1 microsecond (larger values programmable)	1 microsecond (larger values programmable)	1 microsecond (larger values programmable)
Oscillator stability	+/-2.5 PPM	+/-20 PPM	+/-100 PPM
<b>Local Interrupts</b>			
External Edge-Triggered Interrupts	12	12	4
External Output Interrupts	12	12	4
Real-Time Clocks	8	8	4
<b>Distributed Interrupts</b>			
Input	12	12	8
Output	12	12	8
<b>Interrupt Response Time</b>			
Interrupt to user process	< 8 microseconds	< 8 microseconds	< 8 microseconds
<b>Packaging</b>			
Form Factor	PCIe	PCI	PCI
Maximum cable length (See Appendix B for calculations.)	30 meters	32 ft.	10 ft.
External Connectors	Molex LFH-60	Molex LFH-60	16 position .1" Latching Header
PCI Performance	x1	66 MHz 64-bit	33 MHz 32-bit
Options	GPS Module, Oven Oscillator	GPS Module, Oven Oscillator	None
<b>Environmental</b>			
Operating Temperature	10° to 40° C	10° to 40° C	10° to 40° C
Storage Temperature	-40° to 65° C	-40° to 65° C	-40° to 65° C
Relative Humidity	10 to 90% (non-condensing)	10 to 90% (non-condensing)	10 to 80% (non-condensing)
<b>Power</b>			
Consumption	~5 watts	~5 watts	~5 watts

# Hardware, Installation and Configuration

---

This chapter provides a description of the RCIM PCI-based boards as well as installation and configuration information.

## Board Descriptions

This section provides illustrations and descriptions of the RCIM III, RCIM II and RCIM I boards.

RCIM II and RCIM I boards mount in a standard PCI slot and the RCIM III board mounts into a standard PCI-e slot on a host system. A connector is mounted on each RCIM for connection to external interrupts, and a synchronization cable is included for daisy-chaining a master RCIM to one or more slave RCIMs.

## RCIM III

### Board Illustration

Figure 2-1 shows the RCIM III board with optional high stability OCXO (Oven Controlled Crystal Oscillator) and GPS modules installed.

Figure 2-1 RCIM III Board

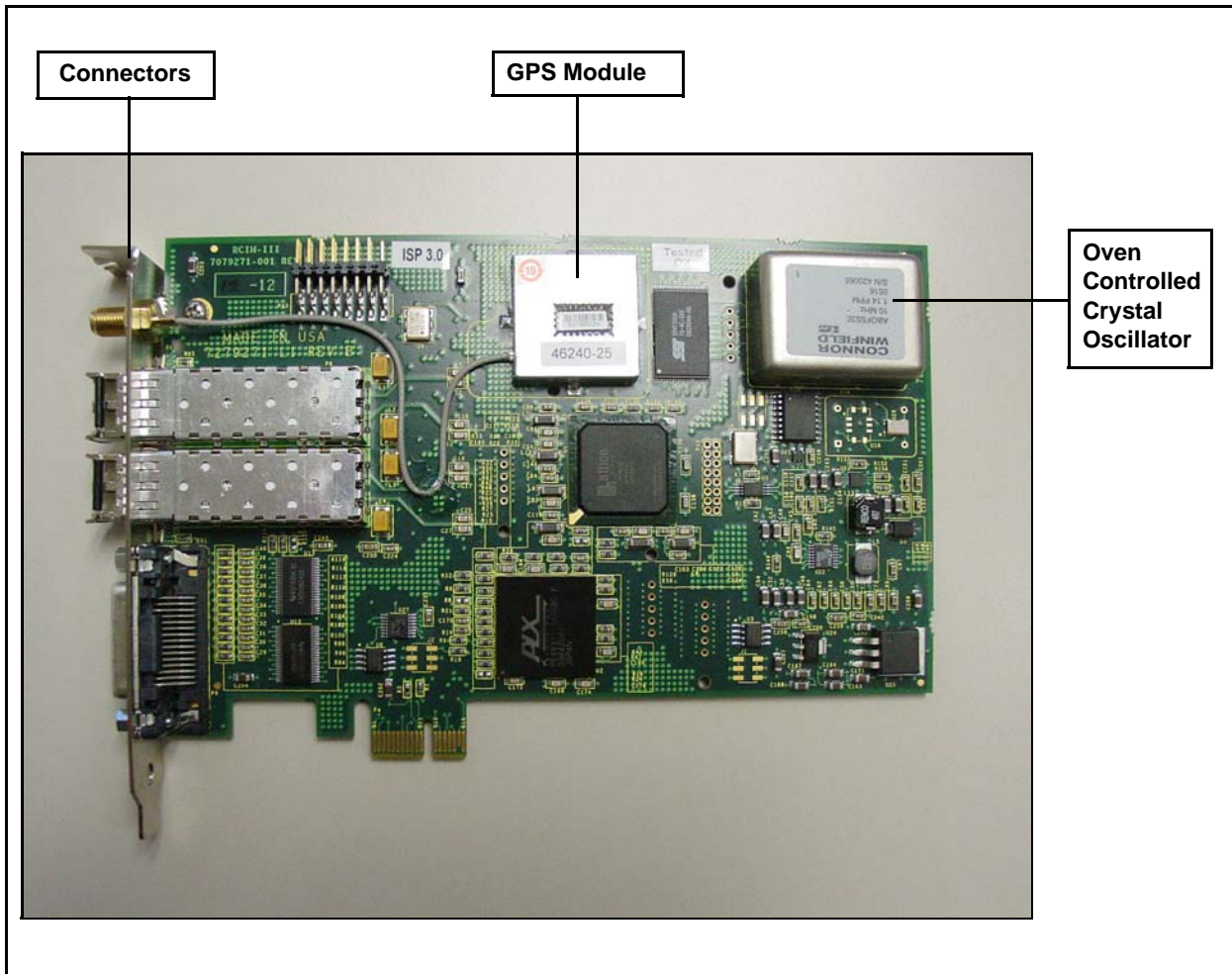

## Connectors and LEDs

Figure 2-2 shows the input/output connectors and LEDs on the RCIM III board. Detailed information on the LEDs and each of the connectors is provided in the following sections.

Figure 2-2 RCIM III Connectors and LED Locations

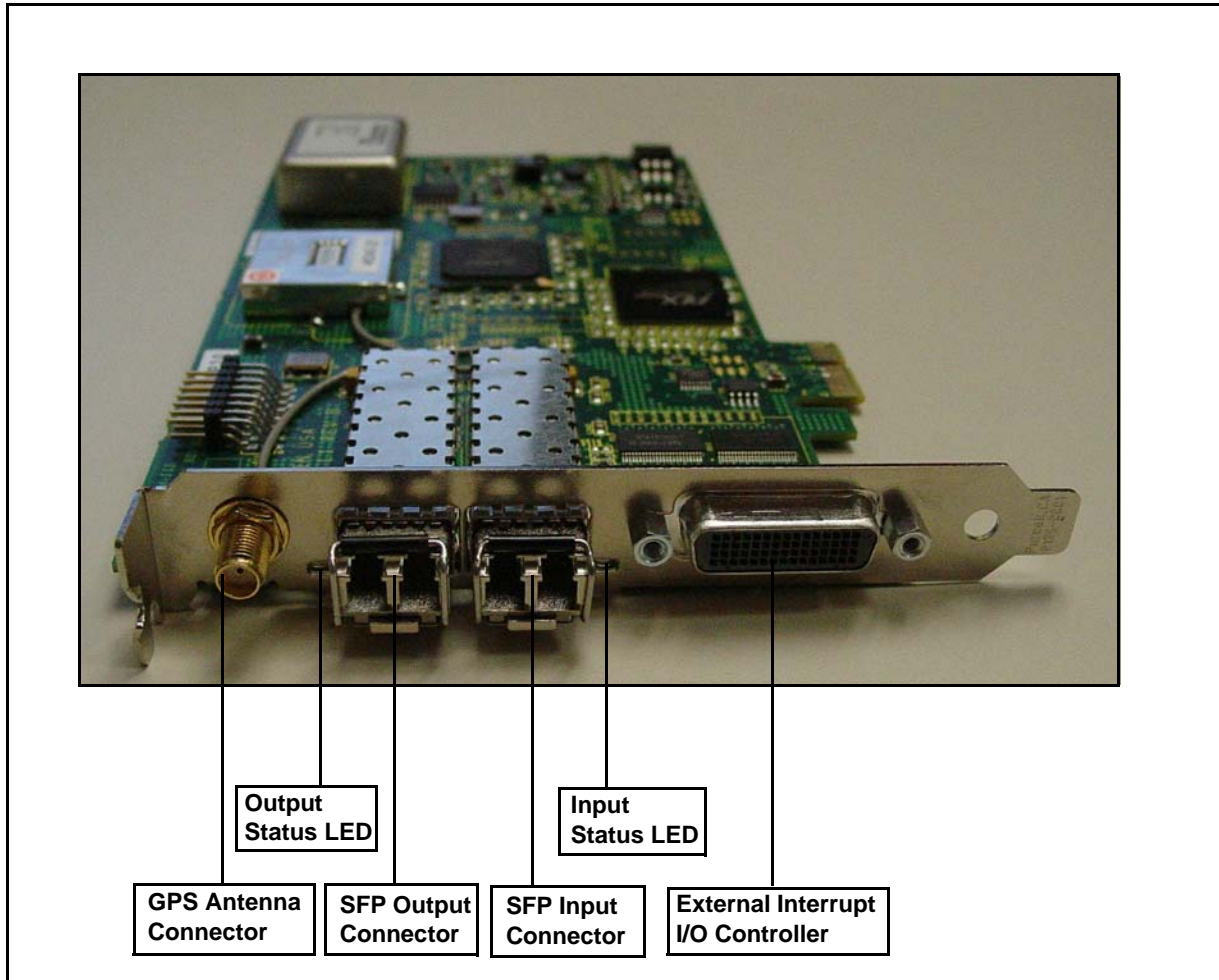

## LED Functions

There are two bi-colored status LEDs near the input and output connectors on the RCIM III board. They will both glow dimly RED when the board is in reset mode

followed by brief intervals of bright RED and GREEN as a test. During normal operation of the board the LEDs function as follows:

LED	description	Function
Output Status LED	RED solid	10 MHz clock failure
	RED 2/sec flash	cable option installed but not synchronized or missing, POSIX clock stopped
	GREEN 1/sec flash	POSIX clock running without cable option
	GREEN 1/sec blink	POSIX clock running with cable attached and synchronized
	RED/GREEN alternating 2/sec flash	POSIX clock running with cable unsynchronized or missing
Input Status LED	RED 2/sec flash	cable option installed but cable unsynchronized or missing
	GREEN solid	cable attached and synchronized

## Input and Output Cables and Connectors

The RCIM III uses a pair of standard SFP (small form-factor pluggable) connectors installed in cages to interface to the RCIM III cable. The cable is used to communicate interrupts, time stamps and a reference clock between RCIM III boards. The output cable connector is used when the RCIM is either the master or a slave in the middle of an RCIM chain (see page 2-18 for a description of RCIM modes). The input cable connector is used when the RCIM is acting in slave mode or in the middle of an RCIM chain. The cable part number (HS002-3CBL-xx where xx is length in meters) includes an LC fiber optic cable and two SFPs that are installed in the empty cages on the master and slave RCIMs. Refer to the section “Daisy Chain Cable” for more information about the cable.

### NOTE

The cable SFPs should only be installed and removed with the system containing the RCIM III powered down. See the Installation section for ESD caution. Care should be taken to insure that the SFP modules lock into position and that the RCIM III is not pushed out of its PCIe slot during the installation of the SFPs. The fiber optic cables themselves can be installed and removed at any time without damaging the RCIM III.

## Oscillators

The temperature compensated crystal oscillator (TCXO) provided with RCIM III has an accuracy of +/- 2.5 PPM (parts per million).

Two optional oven controlled crystal oscillators (OCXO) provide a temperature stability of +/- 210 PPB (parts per billion) or +/- 10 PPB (parts per billion).

## **GPS Antenna**

The GPS option on the RCIM III includes an active GPS antenna and coaxial cable.

The antenna receives the GPS satellite signals and passes them to the receiver. The GPS signals are spread spectrum signals in the 1575 MHz range and do not penetrate conductive or opaque surfaces. Therefore, the antenna must be located outdoors with a clear view of the sky.

If a different antenna or cable is used, it should match the following specifications:

- 50 Ohm impedance
- 27 dB gain
- 3.3 volt DC power max 30 ma.

## **External Interrupt I/O Connector**

The external interrupt I/O connector on the RCIM III is a Molex LFH-60 (Low Force Helix) that provides twelve outputs and twelve inputs.

The external outputs allow equipment to be attached and controlled by the RCIM. The outputs are driven by a multiplexer which can select any of the programmable interrupt generators (PIGs), real-time clock timers (RTCs), edge-triggered interrupts (ETIs) or distributed interrupts (DIs) to drive the output. The selection is controlled by a set of configuration registers.

See Chapter 3 for information on using external output interrupts and programmable interrupts.

The pin-outs for the external interrupt I/O connector are shown in Figure 2-3.

Figure 2-3 RCIM III External Interrupt I/O Connector Pin-outs

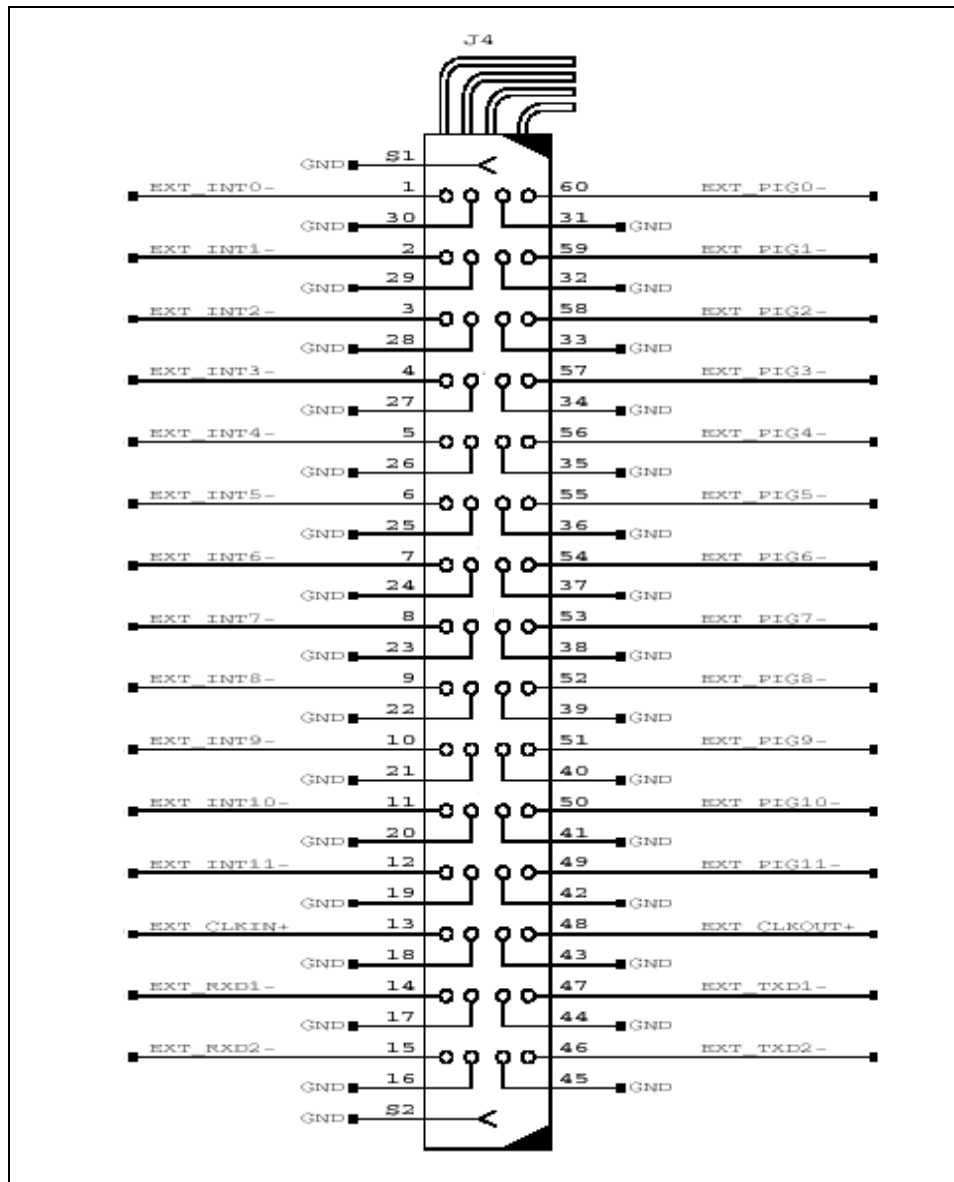

The external interrupt input signals are 5 volt ttl levels. The external interrupt outputs (labeled EXT\_PIG[0-11]) are driven using a 74ABT16240 line driver. The external interrupt inputs are terminated with 180 ohms to +5 volts, 330 ohms and 0.1 uf to ground. To drive this input requires a line driver that can sink at least 30 ma. The input termination limits the speed of the external interrupt signals and helps prevent noise from causing spurious interrupts. Since most line drivers can sink more current than they can source, the falling edge of the signal will be faster.

The signals EXT\_CLKIN and EXT\_CLKOUT are used for external 10MHz clocks in or out. An external clock driving the RCIM III should be capable of driving a 5V ttl signal into a 50 ohm load. The RCIM III will automatically switch to using the external clock if one is present. The external clock output from the RCIM III is driven using a 74ABT16240 line driver.



The signals EXT\_RXD1, EXT\_TXD1, EXT\_RXD2, and EXT\_TXD2 are RS-232 level signals. They are currently used for debug purposes.

## System Identification

The following output to `lspci (8)` shows the PCI class, vendor and device IDs for the RCIM III (0e:04.0 (*bus:slot.function*) will differ on your system):

```
# lspci -v | grep -i rcim
0e:04.0 System peripheral: Concurrent Computer Corporation RCIM III
Real-Time Clock & Interrupt Module (PCIe) (rev 01)
# lspci -ns 0e:04.0
0e:04.0 Class 0880: 1542:9271 (rev 01)
```

## Daisy Chain Cable

The RCIM III uses a fiber optic serial synchronization cable with SFP (small form-factor pluggable) connectors (part no. HS002-3CBL-xx) to connect RCIM IIIs in an RCIM chain. The serial data on the cable includes parity and framing information which allow cable problems to be detected. Polling is done continuously and messages that report the status of the RCIM III daisy chain cables are output when an error condition is detected. Messages indicating problems will appear on the systems directly connected by a failing link.

The serial cables are point to point connections. The “input” cable refers to the cable going upstream towards the master RCIM. The “output” cable is the downstream connection away from the master.

```
RCIM: Input cable disconnected.
RCIM: Input cable connected.
RCIM: Input cable connected but not synchronized.
RCIM: Input cable unsynchronized.
RCIM: Input cable O.K.

RCIM: Output cable disconnected.
RCIM: Output cable connected.
RCIM: Output cable connected but not synchronized.
RCIM: Output cable unsynchronized.
RCIM: Output cable O.K.

RCIM: Cable error on input cable.
RCIM: Cable error on output cable.
```

The “disconnected” and “connected” messages will only occur based on whether an SFP is installed in the appropriate cage of the RCIM III.

They will not occur when the optical cable is inserted or removed. They should not occur during normal operation unless the SFP is not installed correctly or it is malfunctioning.

The “not synchronized” and “unsynchronized” messages indicate that the cable is not answering attempts to communicate. These messages will occur when the optical cable is installed or removed. They will also occur when a connected system is powered off.

The last two messages indicate transient errors such as cable parity errors or temporary loss of cable synchronization. If a transient error occurs, it may require a link in the cable to resynchronize. If a distributed interrupt is being broadcast on the cable, it may be lost.

Transient errors also affect the synchronization of the tick timers since the cable clock will not reach all of the systems. Refer to Chapter 3 for instructions for synchronizing clocks.

## RCIM II

### Board Illustration

Figure 2-4 shows the RCIM II board with optional high stability OXCXO (Oven Controlled Crystal Oscillator) and GPS modules installed.

Figure 2-4 RCIM II Board

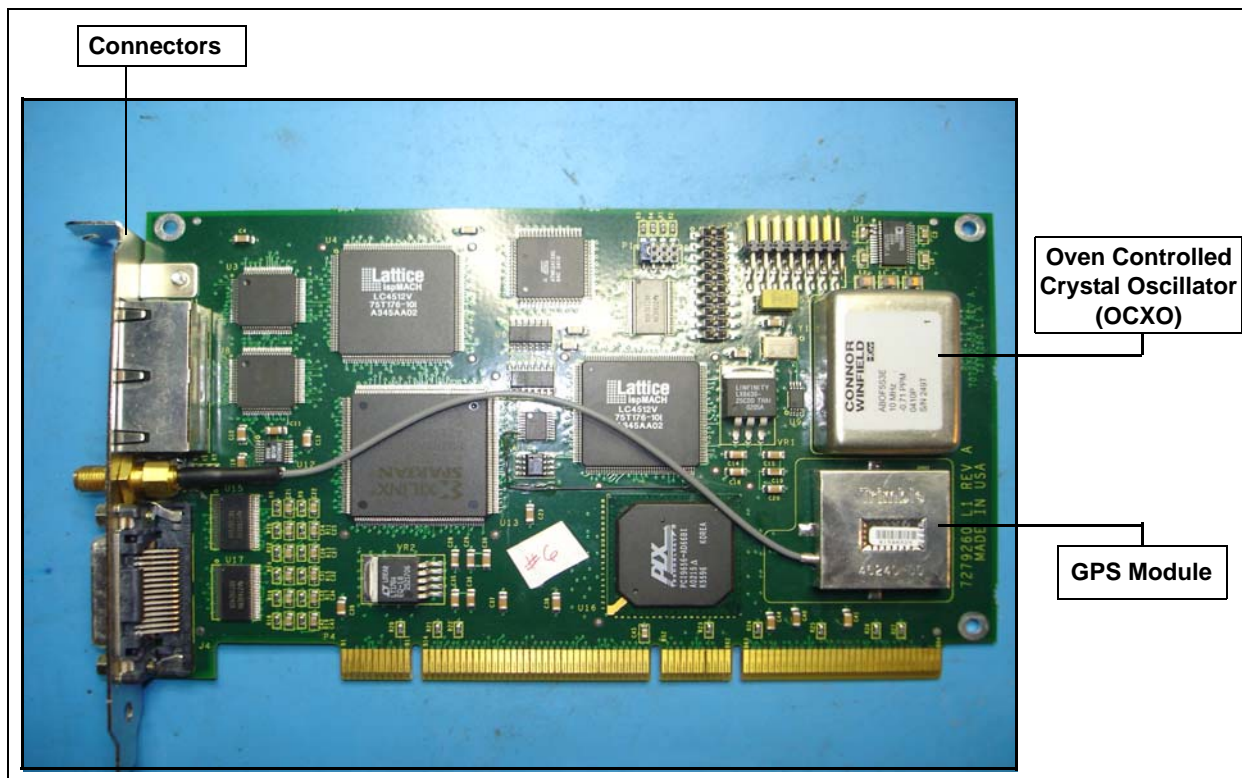

### Connectors and LEDs

Figure 2-5 shows the input/output connectors and LEDs on the RCIM II board.

Detailed information on the LEDs and each of the connectors is provided in the following sections.

**Figure 2-5 RCIM II Connectors and LED Locations**

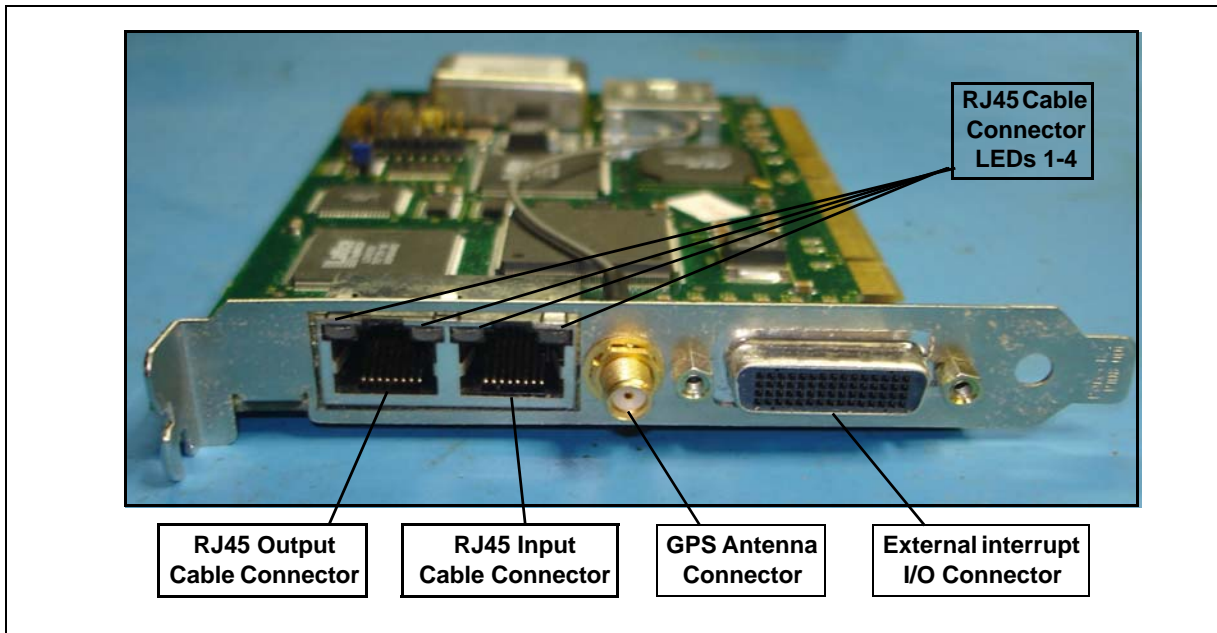

## LED Functions

The four LEDs for the RJ45 input and output connectors on the RCIM II board function as follows:

Connector	LED	Function
RJ45 Output Cable Connector	LED 1	Red -- Failure, Green -- Activity
	LED 2	Cable status: off      cable not connected yellow   cable connected but not synchronized green    cable connected and synchronized
RJ45 Input Cable Connector	LED 3	Always flashing green
	LED 4	Cable status: off      cable not connected yellow   cable connected but not synchronized green    cable connected and synchronized

## Input and Output Cable Connectors

The output cable connector is used when the RCIM II is either the master, or a slave in the middle of an RCIM chain (see page 2-18 for a description of RCIM modes). The input cable connector is used when the RCIM is acting in slave mode.

The cable attached to the output cable connector is an RJ45 serial synchronization cable (part no. HS002-CBL-10). Refer to the section "Daisy Chain Cable" for more information about the cable.

Note that although RJ45 cables are used with Gigabit Ethernet, the RCIM II cables are not Ethernet compatible.

## Oscillators

The standard crystal oscillator provided with RCIM II has an accuracy of +/- 20 PPM (parts per million).

Two optional oven controlled crystal oscillators (OCXO) provide a temperature stability of +/- 210 PPB (parts per billion) or +/- 10 PPB (parts per billion).

## GPS Antenna

The GPS option on the RCIM II includes an active GPS antenna and coaxial cable.

The antenna receives the GPS satellite signals and passes them to the receiver. The GPS signals are spread spectrum signals in the 1575 MHz range and do not penetrate conductive or opaque surfaces. Therefore, the antenna must be located outdoors with a clear view of the sky.

If a different antenna or cable is used, it should match the following specifications:

- 50 Ohm impedance
- 27 dB gain
- 3.3 volt DC power max 30 ma.

## External Interrupt I/O Connector

The external interrupt I/O connector on the RCIM II is a Molex LFH-60 (Low Force Helix) that provides twelve outputs and twelve inputs.

The external outputs allow equipment to be attached and controlled by the RCIM. The outputs are driven by a multiplexer which can select any of the programmable interrupt generators (PIGs), real-time clock timers (RTCs), edge-triggered interrupts (ETIs) or distributed interrupts (DIs) to drive the output. The selection is controlled by a set of configuration registers.

See Chapter 3 for information on using external output interrupts and programmable interrupts.

The pin-outs for the external interrupt I/O connector are shown in Figure 2-6.

Figure 2-6 RCIM II External Interrupt I/O Connector Pin-outs

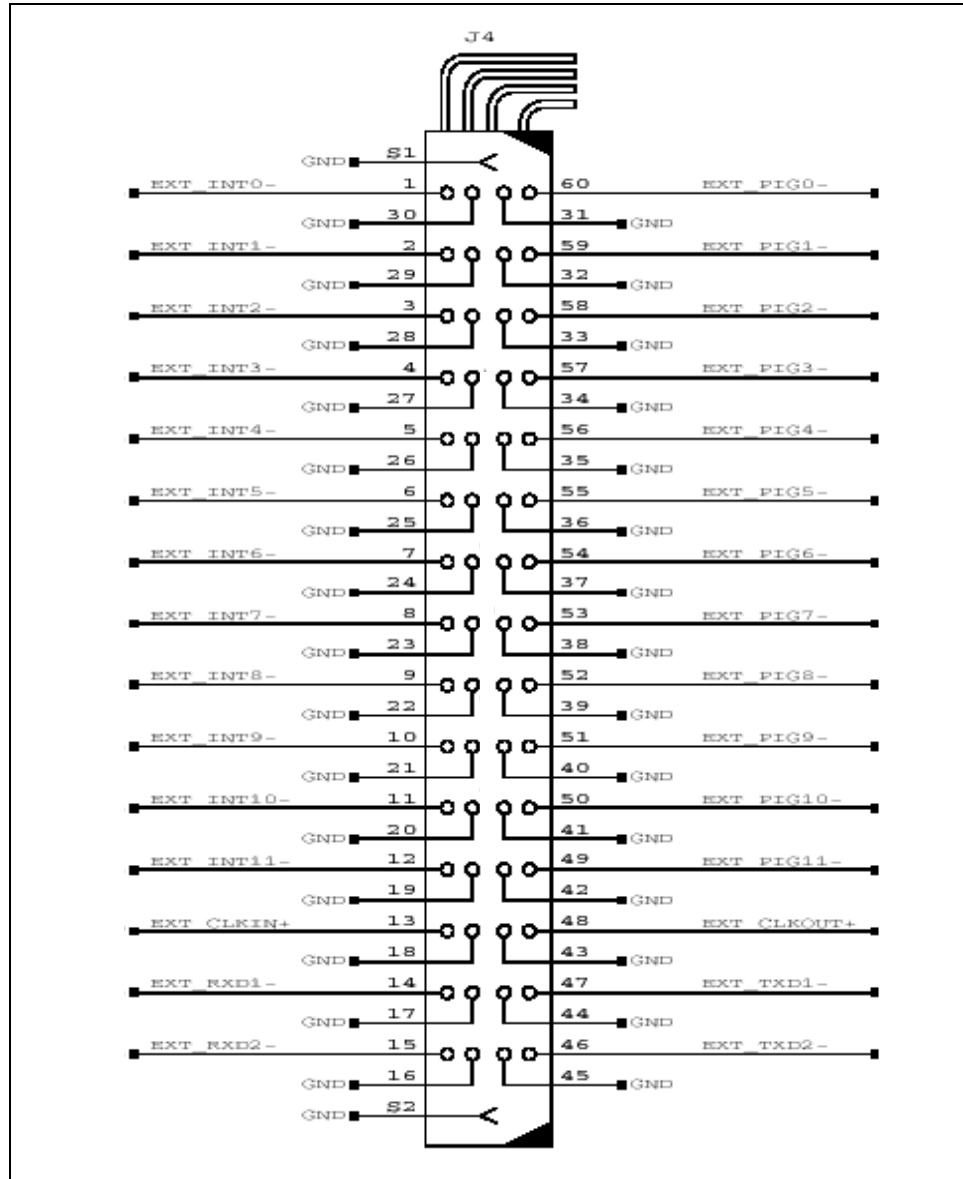

The external interrupt input signals are 5 volt ttl levels. The external interrupt outputs (labeled EXT\_PIG[0-11]) are driven using a 74ABT16240 line driver. The external interrupt inputs are terminated with 180 ohms to +5 volts, 330 ohms and 0.1 uf to ground. To drive this input requires a line driver that can sink at least 30 ma. The input termination limits the speed of the external interrupt signals and helps prevent noise from causing spurious interrupts. Since most line drivers can sink more current than they can source, the falling edge of the signal will be faster.

The signals EXT\_CLKIN and EXT\_CLKOUT are used for external 10MHz clocks in or out. An external clock driving the RCIM II should be capable of driving a 5V ttl signal into a 50 ohm load. The RCIM II will automatically switch to using the external clock if one is present. The external clock output from the RCIM II is driven using a 74ABT16240 line driver.

The signals EXT\_RXD1, EXT\_TXD1, EXT\_RXD2, and EXT\_TXD2 are RS-232 level signals. They are currently used for debug purposes.

## System Identification

The following output to **lspci (8)** shows the PCI class, vendor and device IDs for the RCIM II (0d:06.0 (*bus:slot.function*) will differ on your system):

```
# lspci -v | grep -i rcim
0d:06.0 System peripheral: Concurrent Computer Corp RCIM II
Realtime Clock and Interrupts Module (rev 01)
# lspci -ns 0d:06.0
0d:06.0 Class 0880: 1542:9260 (rev 01)
```

## Daisy Chain Cable

The RCIM II uses an RJ45 serial synchronization cable (part no. HS002-CBL-10) to connect RCIM IIs in an RCIM chain. The serial data on the cable includes parity and framing information which allow cable problems to be detected. Polling is done continuously and messages that report the status of the RCIM II daisy chain cables are output when an error condition is detected. Messages indicating problems will appear on the systems directly connected by a failing link.

The serial cables are point to point connections. The “input” cable refers to the cable going upstream towards the master RCIM. The “output” cable is the downstream connection away from the master.

```
RCIM: Input cable disconnected.
RCIM: Input cable connected.
RCIM: Input cable connected but not synchronized.
RCIM: Input cable unsynchronized.
RCIM: Input cable O.K.
```

```
RCIM: Output cable disconnected.
RCIM: Output cable connected.
RCIM: Output cable connected but not synchronized.
RCIM: Output cable unsynchronized.
RCIM: Output cable O.K.
```

```
RCIM: Cable error on input cable.
RCIM: Cable error on output cable.
```

The “not synchronized” and “unsynchronized” messages indicate that the cable is connected but not answering attempts to communicate. This would be the case if the connected system was powered off.

The last two messages indicate transient errors such as cable parity errors or temporary loss of cable synchronization. If a transient error occurs, it may require a link in the cable to resynchronize. If a distributed interrupt is being broadcast on the cable, it may be lost. Transient errors also affect the synchronization of the tick timers since the cable clock will not reach all of the systems. Refer to Chapter 3 for instructions for synchronizing clocks.

## RCIM I

This section provides illustrations and descriptions of the RCIM I board.

### Board Illustration

Figure 2-7 shows the RCIM I board.

Figure 2-7 RCIM I Board

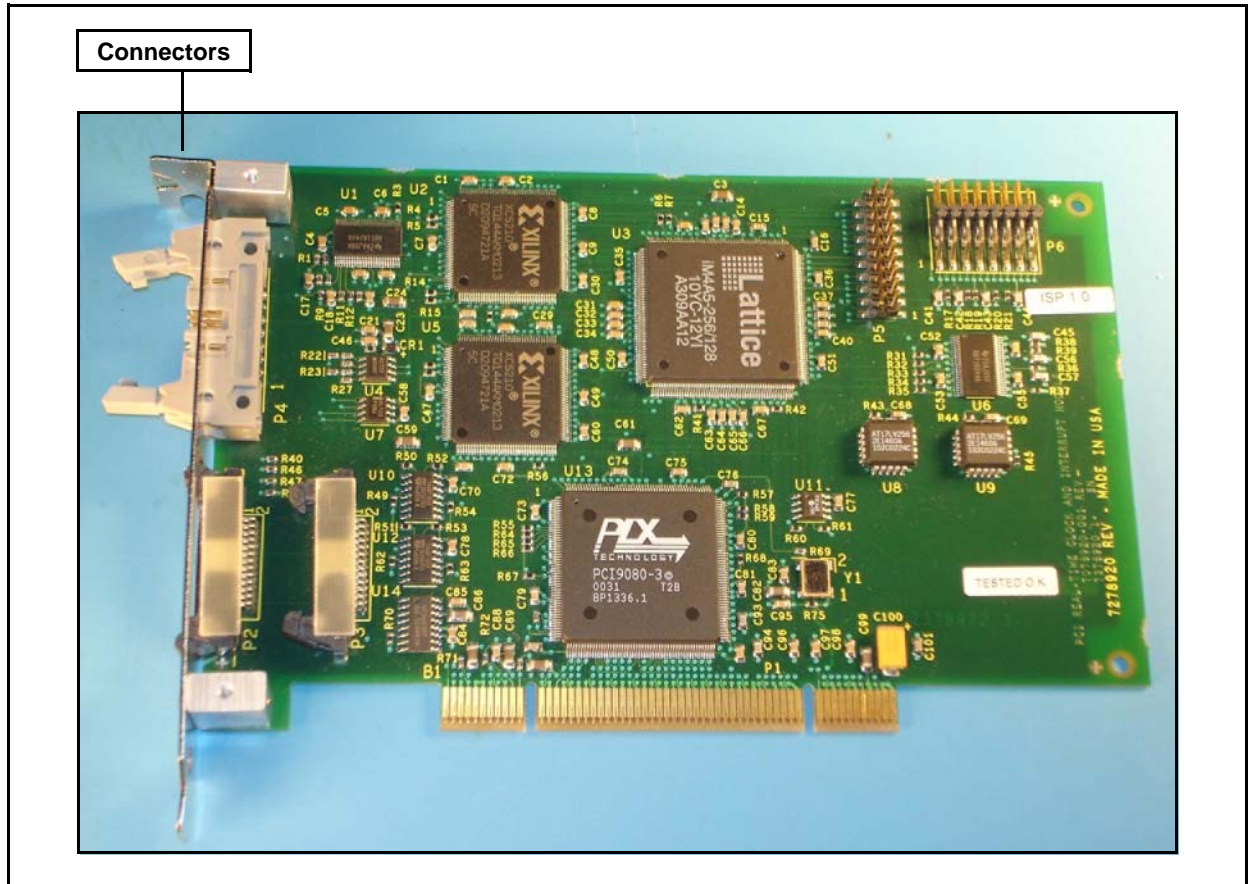

## Connectors and LEDs

Figure 2-8 shows the input/output connectors and LEDs on the RCIM I board.

Detailed information on the LEDs and each of the connectors is provided in the following sections.

**Figure 2-8 RCIM I Connectors and LED Locations**

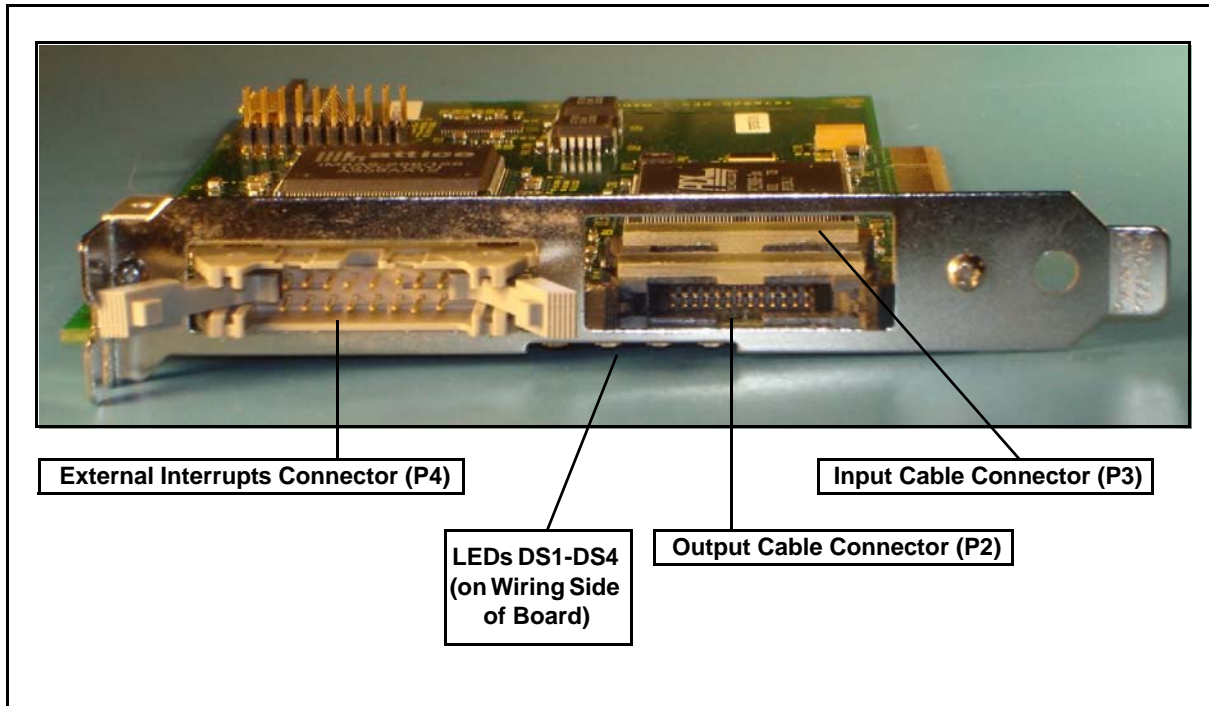

## LED Functions

The four LEDs are on the circuit side of the RCIM I board between the output cable connector (P2) and the external interrupts connector (P4). They function as follows:

LED	Number	Function
Red	DS1	If on after reset, indicates RCIM module failed power-up reset.
Yellow	DS2	If on, indicates cable clock not connected.
Green	DS3	If on, indicates activity in progress.
Green	DS4	If on, indicates power applied to RCIM.



## Output Cable Connector (P2)

The output cable connector is used when the RCIM I is either the master, or a slave in the middle of an RCIM chain (see page 2-18 for a description of RCIM modes). The cable attached to the output cable connector is called a synchronization cable (part no. 6010178-109). The pin-outs for the output cable connector are shown in Figure 2-9.

Figure 2-9 RCIM I Output Cable Connector (P2) Pin-outs

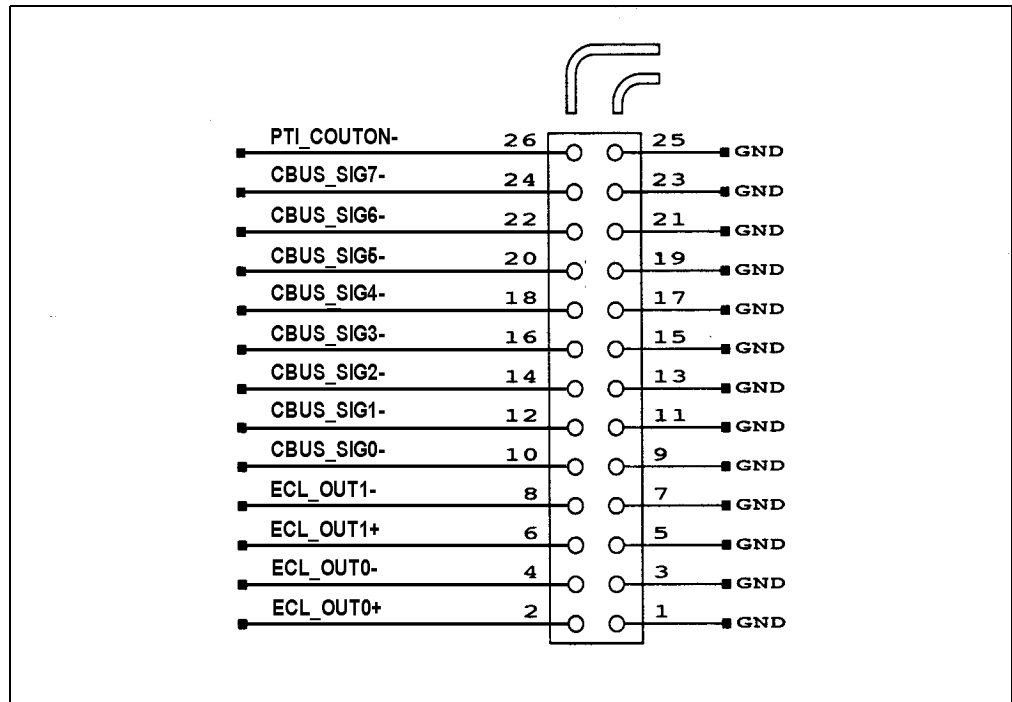

## Input Cable Connector (P3)

The input cable connector is used when the RCIM I is acting in slave mode (see page 2-18 for a description of RCIM modes). The cable attached to the input cable connector is called a synchronization cable (part no. 6010178-109). The pin-outs for the input cable connector are shown in Figure 2-10.

Figure 2-10 RCIM I Input Cable Connector (P3) Pin-outs

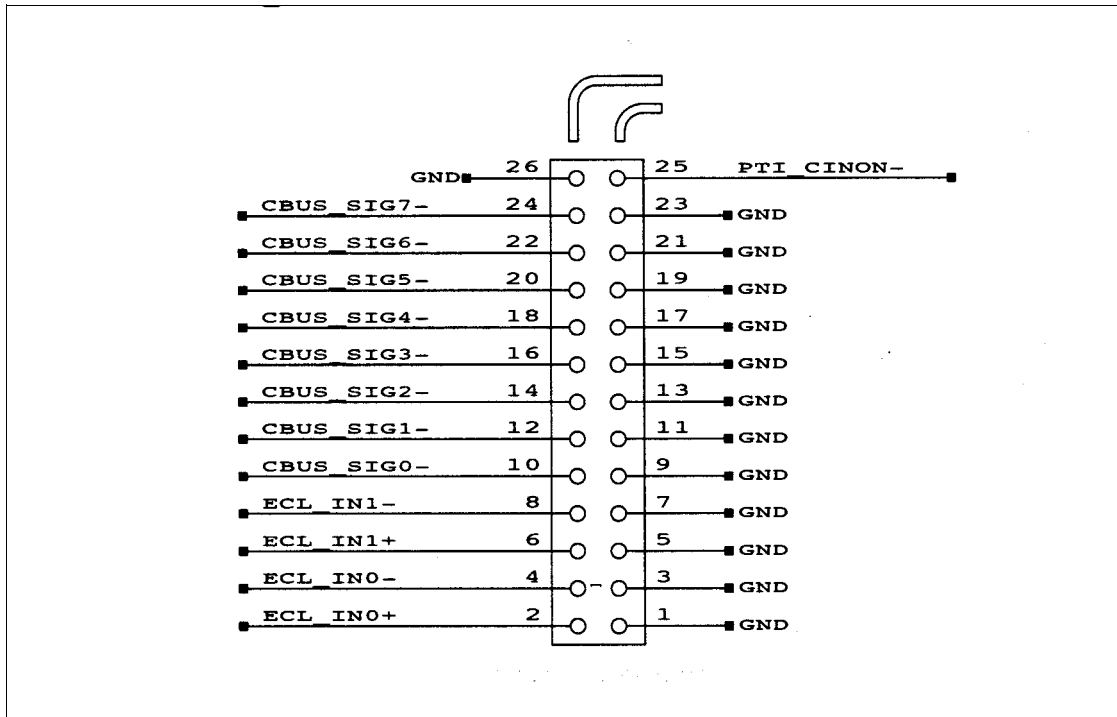

## External Interrupts Connector (P4)

The external interrupts connector on the RCIM I provides four outputs and four inputs.

The external outputs allow equipment to be attached and controlled by the RCIM. The outputs are driven by a multiplexer which can select any of the programmable interrupt generators (PIGs), real-time clock timers (RTCs), edge-triggered interrupts (ETIs) or distributed interrupts (DIs) to drive the output. The selection is controlled by a set of configuration registers.

See Chapter 3 for information on using external output interrupts and programmable interrupts.

Pin-outs for the external interrupts connector are shown in Figure 2-11.

**Figure 2-11 RCIM I External Interrupts Connector (P4) Pin-outs**

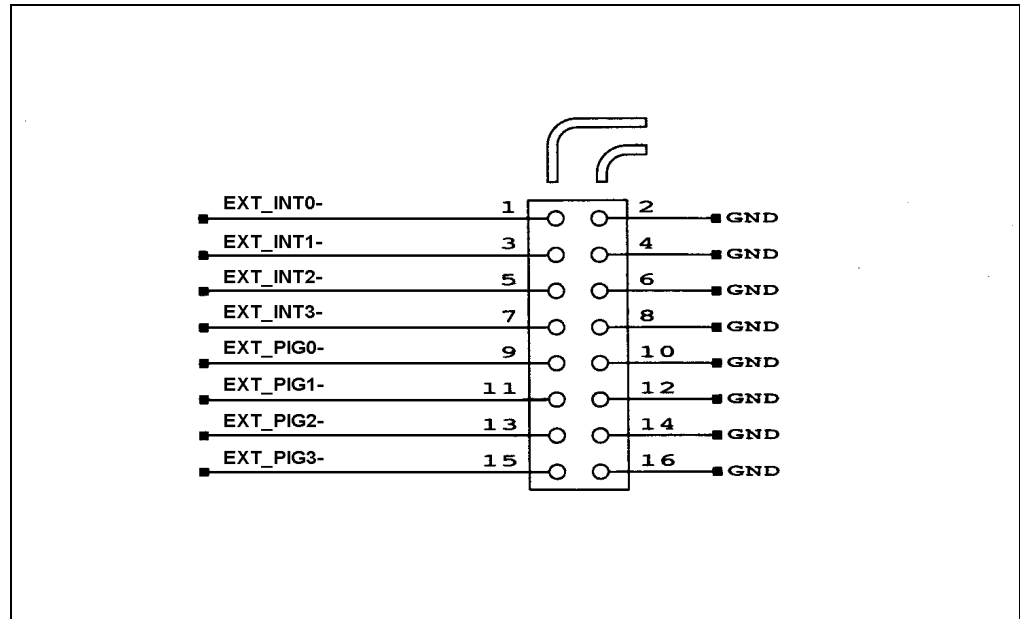

## Debug Visibility Connector (P5)

The debug visibility connector is intended for use on the Concurrent Computer Corporation manufacturing floor and should not be used outside of that environment.

## In-System Programming Interface Connector (P6)

The in-system programming interface connector is intended for use on the Concurrent Computer Corporation manufacturing floor and should not be used outside of that environment.

## System Identification

The following output to `lspci (8)` shows the PCI class, vendor and device IDs for the RCIM I (0d:06.0 (*bus:slot.function*) will differ on your system):

```
# lspci -v | grep -i rcim
0d:06.0 System peripheral: PLX Technology, Inc. RCIM Realtime
Clock and Interrupts Module old ID (rev 01)
# lspci -ns 0d:06.0
0d:06.0 Class 0880: 10b5:8845 (rev 01)
```

## Connection Modes

When RCIM boards of various systems are chained together, an interrupt can be simultaneously distributed to all connected RCIMs, and from the RCIMs to all the associated host systems.

### NOTE

All RCIMs in a chain must be the same model; for example, all RCIM IIs.

If your system will be part of an RCIM chain, it is best to determine the desired connection mode before installing an RCIM; it is easier to connect the cable to the cable connectors before the RCIM is installed.

Note that to reconfigure an RCIM chain, the systems must be powered off and rebooted after moving the cables. The driver determines if a system is the master RCIM at boot time and configures the master system to control the cable clock and its enable. Swapping the cables without rebooting the systems will result in problems with the cable clock.

An RCIM can be connected in one of the following modes:

Isolated mode	There are no connections to any other RCIM.
Master mode	The RCIM is at the head of a chain of RCIMs. There is no cable connection going into this RCIM, only a cable connection going out. The RCIM master is unique in that it controls the clocks (see Chapter 3 for a discussion).
Pass-through Slave mode	The RCIM is connected to two other RCIMs. There is an input cable connection coming from the previous RCIM in the chain, and an output cable connection going to the next RCIM in the chain.
Final Slave mode	The RCIM is connected to one other RCIM. There is an input cable connection going into a final slave RCIM but no output cable connection coming out of it.

## Unpacking the RCIM

When unpacking the equipment from the shipping container, refer to the packing list and verify that all items are present. Save the packing material for storing and reshipping the equipment.

### NOTE

If the shipping container is damaged upon receipt, request that the carrier's agent be present during unpacking and inspection of the equipment.

# Installation

Normally, installation and configuration of the card is done by Concurrent Computer Corporation. This information is provided for those cases where an RCIM is added to a system in a post-manufacturing environment.

In order to successfully install the RCIM, you must know if you will be using the RCIM to accept or deliver external interrupts and the mode in which the RCIM will run (isolated, master, pass-through slave or final slave). Refer to the section “Connection Modes” above for details.

## CAUTION

Avoid touching areas of integrated circuitry as static discharge can damage circuits.

Concurrent Computer Corporation strongly recommends that you use an antistatic wrist strap and a conductive foam pad when installing or upgrading a system. Electronic components such as disk drives, computer boards, and memory modules can be extremely sensitive to Electrostatic Discharge (ESD). After removing the board from the system or its protective wrapper, place it flat on a grounded, static-free surface, component side up. Do not slide the board over any surface.

If an ESD station is not available, you can avoid damage resulting from ESD by wearing an antistatic strap (available at electronic stores) that is attached to an unpainted metal part of the system chassis.

Use the following procedure to install an RCIM in your system:

1. Ensure that your system is powered down.
2. Remove the power cable from the system.
3. Open the case of your system and identify the PCIe slot (RCIM III) or PCI slot (RCIM II or RCIM I) where you want the RCIM to reside. In general, it is best for the RCIM to be configured in a slot where minimal or no contention with other devices occurs and at the highest IRQ priority possible. Refer to the *iHawk Optimization Guide*, publication number 0898011, for slot configuration guidelines.
4. Install the RCIM into the desired slot, securing the card in the slot using the mechanism provided by the case.
5. If this is to be part of an RCIM chain, attach the cable as required. See the section “Connection Modes” to determine how to connect the cable based on the connection mode for this system.
6. If you are installing an RCIM board equipped with the optional GPS module, attach the GPS antenna lead and mount the antenna. The antenna should be mounted on the rooftop or in an open area. Refer to the sections “Connectors and LEDs” and “GPS Antenna” more information about the antenna.
7. Replace the cover.
8. Attach the power cable to the system.
9. Apply power and boot the system.

## Configuration

### Kernel Configuration

The following RedHawk Linux kernel parameters are associated with the RCIM. All are accessible through the **Character Devices** selection of the Kernel Configuration GUI and are enabled by default in all the pre-built RedHawk Linux kernels.

RCIM	This parameter configures the RCIM driver in the kernel. It can be configured as a module, if desired.
MULTI_RCIM	Selects whether the multi-board or the single-board RCIM driver is to be compiled into the kernel. The multi-board driver is used by default.
RCIM_MASTERCLOCK	This parameter enables the RCIM to be used as a master clock that monitors and adjusts system time, resulting in more precise system timekeeping.
RCIM_PPS	This parameter disciplines the RCIM tick and POSIX time-of-day registers to the pulse-per-second support of the optional GPS receiver. This provides for time more closely aligned to the official atomic time as defined by the GPS system. This option has no effect if your RCIM does not have GPS capability.
RCIM_IRQ_EXTENSIONS	This parameter allows other drivers to attach their own interrupt routines to the RCIM driver. The Frequency-based Scheduler (FBS) requires this support.

For complete information about modifying kernel tunables and building a kernel, refer to the *RedHawk Linux User's Guide*, publication number 0898004.

### Driver Configuration

This section describes two methods for configuring an RCIM board: dynamic, via the writing of a string to a `/proc` file, and static, via boot time (or module load time) options. The single-board RCIM driver supports static and dynamic, however the multi-board driver supports only the dynamic method.

#### Static Configuration

When the single-board RCIM driver initializes on a system, it looks at the value of a single tunable (`rcim=RCIMoptions`) for its configuration options. For a statically linked RCIM driver, this tunable can be specified on the GRUB boot loader command line. For an RCIM in module form, this tunable can be specified on the `insmod(8)` command line, or be placed in `modprobe.conf(5)` where the `modprobe(8)` invocation in the startup script `/etc/init.d/rcim` will find it.

The following functionality is defined with the `rcim` tunable:

- the manner in which various interrupts will be triggered: rising or falling edge, high or low level
- associations between interrupts, output lines and distributed interrupt lines
- the name of the system in an RCIM chain that has the master RCIM
- whether tick clocks are to run locally or be synchronized with the clock of the master RCIM system in a chain
- whether the RCIM is registered as a master clock

The `rcim` tunable accepts a comma-separated list of options. For example:

```
rcim='host/server1.ccur.com, eti1/rising, di3/high, rtc3|di6'
```

In this example for an RCIM slave system, the RCIM master system name is `server1.ccur.com`, edge-triggered interrupt (eti) #1 is configured to trigger on the rising edge, distributed interrupt (di) #3 triggers on a high value, and distributed interrupt line (di) #6 is to be driven by real-time clock timer (rtc) #3.

The `sync/nosync` options affect clock synchronization across an RCIM chain. “sync” specifies that the RCIM is to use the cable clock driven by the master RCIM’s local clock. This is the default. “nosync” specifies that the RCIM uses its local clock.

The `clock/noclock` options define whether the RCIM is registered as a clocksource for the system. The default is “clock.” Note that once the RCIM is registered as a clocksource, it cannot be “unregistered.” Also if the RCIM is configured as a module and registered as a clocksource, the module will be locked in (“`rmmod rcim`” will fail).

On RCIM III and RCIM II systems, the timing sources for RTCs, tick and POSIX clocks can be configured individually, if desired. For example,

```
rcim=nosync/r, sync/tp
```

selects the local clock for the RTCs (`r`) and the cable clock for the tick (`t`) and POSIX (`p`) clocks. If specifiers are not provided for `sync` and `nosync`, all three clocks are set according to the option in effect.

## Dynamic Configuration

Configurations can be modified dynamically using `echo (1)` to write a configuration string, in the format used by the `rcim` tunable, to `/proc/driver/rcimN/config` (where `N` is the RCIM card number starting from zero). For example:

```
echo eti1/f > /proc/driver/rcim0/config
```

changes eti #1 to trigger on a falling edge. Quotes must be used to surround a configuration request that contains a vertical bar; for example:

```
echo "rtc0|di1" > /proc/driver/rcim2/config
```

Configuration modifications made in this way are not retained when the system is rebooted. Making these changes requires write permission to the file and should only be made when the RCIM is not in use.

Refer to Chapter 3 or the `rcim(4)` man page for complete information about configuration defaults and selections for each interrupt type.

## General Considerations

When configuring the RCIM systems, keep the following in mind:

- For a chain of RCIMs, the tick clock and POSIX clock in all slave RCIMs will be synchronized with the master because the clock signal incrementing time in the master is broadcast to all slaves. Once the clocks on all RCIMs are initially synchronized they will remain synchronized.

To synchronize tick clocks, a working TCP/IP connection between all systems is needed. In addition, each slave RCIM hostname configuration must be set to the master RCIM, and each slave must be configured to run the `rcim_clocksync` init script once on boot. This is only required if your application is using the tick clock for synchronization.

`ntp` can be used to synchronize the POSIX clocks, however for the RCIM-III there is a better mechanism: `rcimdate(8)`. The RCIM-III master broadcasts its POSIX time down the RCIM cabling once per second; `rcimdate` uses this to make the slave POSIX clocks exactly match the master. This has several advantages over `ntp`: no TCP/IP connections between systems are required, synchronization is faster, and synchronization is extremely accurate.

- Interrupts, whether operating locally or distributed across an RCIM chain, will be processed according to the values configured on each system. If you wish them to function in a manner different from established defaults, the desired configuration options must be specified.
- When distributing interrupts across the systems in an RCIM chain, all systems must have a compatible configuration for the distributed interrupt lines.

## MSI Interrupt Configuration

The latest version of RCIM III (revision 9 and later) supports MSI (message signaled interrupts). By default, the RCIM kernel driver will initialize the hardware to use MSI interrupts instead of PCI INTA interrupts whenever possible. By using MSI interrupts, the RCIM III is guaranteed of having its own non-shared interrupt, thus providing more reliable interrupt response times.

The RCIM driver has an `rcim.noms_i=1` option which is independent of the `rcim=` configuration option described earlier. All versions of the driver have this option. If specified the MSI capability is disabled on all RCIM boards that support it. There is no mechanism to pick which boards are to be MSI-disabled and which ones are not. When this option is specified, the RCIM driver will fallback to using the PCI INTA interrupt method. For performance reasons, this option should only be used if a problem with MSI interrupts is encountered.

For a statically linked RCIM driver, this tunable can be specified on the GRUB boot loader command line (`rcim.noms_i=1`). For an RCIM in module form, this tunable can be placed in `/etc/modprobe.conf` as “options `rcim.noms_i=1`”.

This option has no effect on RCIM II or RCIM I systems.



## ntp Configuration for GPS Support

If your system contains the optional GPS module, **ntp** must be installed and configured to use the GPS receiver to synchronize the RCIM's POSIX clock to GPS time. Follow these steps:

1. Verify that the latest ntpd rpm is installed on the system:

```
# rpm -ql ccur-ntp-4.2.2p1-7*
```

\* includes possible updates (.1, .2, etc.) and the architecture type, **i386** or **x86\_64**.

If it is not installed, refer to the *RedHawk Linux Release Notes*, publication number 0898003, for instructions to install this rpm from the RedHawk installation media.

2. The file `/etc/ntp.conf` supplied with the rpm contains the following lines that are required to use the GPS.

```
server 127.127.8.0 mode 138 prefer #PARSE TSIP (10)+ PPS(128)
fudge 127.127.8.0 flag3 1 #enable PPS signal
```

The following three lines define a pool of world-wide servers that are randomly selected at poweron for time synchronization. This feature acts as the default NTP configuration and serves as backup to GPS. You may wish to include your local country code before "pool" in these entries for best results; e.g., `0.us.pool.ntp.org`. See [www.pool.ntp.org](http://www.pool.ntp.org) for more information.

```
server 0.pool.ntp.org
server 1.pool.ntp.org
server 2.pool.ntp.org
```

A block of commented out entries beginning with "logfile" is used to configure files used for logging statistics. Uncomment the entries if you wish to enable them.

In addition to the log files, **ntpq(1)** and **ntpd(1)** are used for NTP monitoring. For more information about NTP, refer to the **ntpd(1)** man page and [www.ntp.org](http://www.ntp.org).

At system poweron, once all data is received from the GPS satellites, accurate timekeeping is available.

## Verifying ntp/GPS Operation

To determine when the GPS is producing accurate time, use the peer listing of **ntpq(1)** as shown below. This example utilizes command line options, however **ntpq** can also be run interactively. Refer to the man page for complete information.

```
# /usr/sbin/ntpq -np
remote          refid                st t  when  poll  reach  delay  offset  jitter
=====
xns2.medbanner.c 192.43.244.18       2  u   33    64    377    72.443 -2.897  11.235
+toshi.keneli.or  .GPS.                1  u   43    64    377    27.915  0.938  2.075
```

```

-216.56.81.86      193.131.101.50  3  u  33   64   377   49.388  -0.579  2.710
+new.localdomain  .GPS.           1  u  42   64   377   0.182   0.010   0.020
*GENERIC(0)       .GPS.           0  1  46   64   377   0.000   0.000   0.001

```

The output shows how the system time compares to other time sources. This includes the GPS receiver and other time servers.

The column labeled `remote` is the hostname of the timeserver. The system `new.localdomain` is a local network time server; `GENERIC(0)` is the GPS attached to the RCIM. The other lines are time servers assigned by `pool.ntp.org`. The first column indicates which servers are being selected for synchronization. The '\*' in front of `GENERIC(0)` indicates that the RCIM GPS receiver is being used as the system peer.

The columns `delay`, `offset`, and `jitter` are all times in milliseconds. The offset is the difference between the local system time and the time source. In this case we are synchronized to the GPS receiver to microsecond accuracy.

The `delay` field is the measured network delay to exchange the time with the remote server.

The `jitter` measures the difference between offset values from the same source.

The `refid` indicates where the remote system gets its time.

The `st` column is the stratum number. A stratum zero system should have a direct connection to an authoritative source.

The `poll` column shows how frequently this server is being polled. The `when` column is the time in seconds since the last poll.

The `reach` column is a bitmap in octal which shows if recent polls have been successful. The value 377 would indicate that the last 8 polls succeeded.

Another indicator is through the `ntpq clockvar` command:

```

# /usr/sbin/ntpq
ntpq> clockvar
assID=0 status=0003 clk_okay, last_clk_fault,
device="Trimble GPS (TSIP) receiver", timecode="\x10\xff\x02\x10",
poll=52, noreply=0, badformat=0, baddata=0, fudgetime1=20.000,
stratum=0, refid=GPS, flags=4,
refclock_ppstime="c66be732.00000000 Tue, Jun 28 2005 15:11:46.000",
refclock_time="c66be734.03ffffff Tue, Jun 28 2005 15:11:48.015",
refclock_status="TIME CODE; PPS; POSITION; (LEAP INDICATION; PPS SIGNAL; POSITION)",
refclock_format="Trimble TSIP",
refclock_states="*NOMINAL: 00:54:26 (98.04%); NO RESPONSE: 00:00:02 (0.06%); FAULT:
00:01:03 (1.89%); running time: 00:55:31",
trimble_tracking_status[08]="ch=4, acq=ACQ, eph=19, signal_level= 6.40, elevation= 9.12,
azimuth= 34.35, collecting data",
trimble_satview="mode: 2D-AUTO, PDOP 8.96, HDOP 8.91, VDOP 1.00, TDOP 2.90, 3 satellites
in view: 18, 26, 29",
trimble_tracking_status[10]="ch=0, acq=ACQ, eph=3, signal_level= 2.60, elevation= 18.18,
azimuth= 86.56, collecting data",
trimble_tracking_status[18]="ch=1, acq=ACQ, eph=19, signal_level= 5.20, elevation= 39.47,
azimuth= 289.19, collecting data",
trimble_tracking_status[26]="ch=2, acq=ACQ, eph=19, signal_level= 15.40, elevation= 69.34,

```

```
azimuth= 49.55, collecting data",
trimble_tracking_status[29]="ch=3, acq=ACQ, eph=19, signal_level= 15.80, elevation= 52.49,
azimuth= 48.45, collecting data",
trimble_receiver_health="doing position fixes, Battery backup failed",
trimble_status="machine id 0x5a, Battery Powered Time Clock Fault, Superpackets
supported",
gps_position_ext(XYZ)="x= 1445085.4m, y= -4476862.4m, z= 4277122.9m",
gps_position_ext(LLA)="lat 42.379423 N, lon 71.531318 W, alt 88.35m",
trimble_tracking_status[15]="ch=7, acq=ACQ, eph=3, signal_level= 3.00, elevation= 28.28,
azimuth= 311.83, collecting data",
trimble_tracking_status[09]="ch=4, acq=ACQ, eph=3, signal_level= 1.60, elevation= 23.21,
azimuth= 163.20, collecting data"
ntpq>
```

The `refclock_states` message in this example indicates that 98.04% of the time the GPS is receiving useful data. A higher nominal number indicates the most accuracy.

Additional information is provided by many other messages in this output. Refer to **ntpq(1)** for complete details



## Functional Description

This chapter describes the clocks and interrupt capabilities provided by the RCIM and the user interfaces for each.

### Overview

The Real-Time Clock and Interrupt Module (RCIM) provides two non-interrupting clocks. One of these clocks can be synchronized with all the RCIMs in an RCIM chain to provide a common time stamp across systems. The other clock is POSIX 1003.1 compliant and, although not synchronized across the RCIM chain, it increments in unison with the other clock on the RCIM board and can be set to a specific time.

In addition to the clocks, the following methods for handling signal processing (interrupts) are available:

- Edge-Triggered Interrupts (ETIs)
- Real-Time Clocks (RTCs)
- External Output Interrupts
- Programmable Interrupt Generators (PIGs)
- Distributed Interrupts (DIs)

These interrupts operate locally on an RCIM system or can be distributed across all RCIM systems in an RCIM chain. The `open(2)`, `close(2)` and `ioctl(2)` system calls are used to manipulate the interrupts. Separate device files are associated with each interrupt.

The clocks and interrupts are described in this chapter.

### Clocks

The RCIM provides two non-interrupting clocks, which are fully explained in the sections that follow.

**tick** a 64-bit non-interrupting clock that increments by one on each tick of the common 400ns clock signal. This clock can be reset to zero and synchronized across the RCIM chain, providing a common time stamp.

**POSIX** a 64-bit non-interrupting clock encoded in POSIX 1003.1 format. The upper 32 bits contain seconds and the lower 32 bits contain nanoseconds. This clock is incremented on each tick of the common clock signal. It is primarily used as a high-resolution local clock. It can be configured to synchronize system time with GPS standard time on boards equipped with GPS.

All clocks on all RCIMs in the chain are incremented in unison, as they are all driven by a common clock signal emanating from the master RCIM.

## The Tick Clock

The tick clock is a 64-bit non-interrupting counter that increments by one on each tick of the common clock signal. Although it cannot be set to a specific time, it can be incremented or set to zero. Hence the tick clock cannot be adjusted on the fly to approximate the current time of day as would be required of a true time-of-day clock. On RCIM I systems, the system clock is frequency-synchronized with the tick clock.

When an RCIM board is part of an RCIM chain, the tick clocks on all slave RCIMs are incremented and cleared in synchronization with whatever incrementing and clearing is done to the tick clock located on the master RCIM.

The tick clock can be read on any system, master or slave, using direct reads when the device file `/dev/rcimN/sclk` (where *N* is the RCIM card number starting from zero) is mapped into the address space of a program. See the section “Direct Access to the Clocks” below for details.

By default, tick clock initialization (zeroing) and synchronization with other tick clocks on the RCIM chain occur automatically whenever the RCIM master boots. Initializing and synchronizing tick clocks is accomplished using the `rcim_clocksync(1)` command. See the sections “Synchronizing the Tick Clock” and “The rcim\_clocksync Utility” below for details.

## The POSIX Clock

The POSIX clock is a 64-bit non-interrupting counter encoded in POSIX 1003.1 format. The upper 32 bits contain seconds and the lower 32 bits contain nanoseconds. This clock is incremented on each tick of the common clock signal. On RCIM III and RCIM II systems, the system clock is synchronized to the POSIX clock.

For RCIM II and III, setting the system clock (for example, with `clock_gettime(2)`) will set both the system clock and the RCIM POSIX clock to the new time. In addition, the POSIX clock can be mapped with `mmap` and then read like any other RCIM register by applications. However, modifying the RCIM POSIX clock via the `mmap` method is not recommended while the system is synchronizing with the RCIM POSIX clock.

The POSIX clock can be loaded with any desired time; however, the value loaded is not synchronized with other clocks in an RCIM chain. Only the POSIX clock of the RCIM attached to the host is updated. See the section “Direct Access to the Clocks” below for details about accessing the POSIX clock.

Although the RCIM I and II have no hardware support for setting the POSIX clocks of all boards to a consistent value, it is possible to pause the operation of the RCIM board chain, synchronize the POSIX clock values during the pause using the `rcim_clocksync(1)` command on each of the systems, then restart the RCIM board chain. See the section “Synchronizing the POSIX Clock” later in this chapter for instructions. For the RCIM III, `rcimdate` can be run on each slave to synchronize the POSIX clock to that of the master. No TCP/IP connection or other software is needed. `rcimdate` utilizes the POSIX timestamp sent down the RCIM cabling once per second by the RCIM III maser.

On an RCIM system with GPS module and NTP running, the GPS receiver is used to synchronize the POSIX clock on the RCIM on which it is attached to GPS time. See the

section “Using GPS for System Timekeeping” for details. Generally, only the master RCIM needs a GPS; slaves use one of the software methods available for synchronizing their POSIX clock to the master.

## Direct Access to the Clocks

The device file `/dev/rcimN/sclk` (where *N* is the RCIM card number starting from zero) can be used to access the RCIM clocks directly using `mmap(2)`. From the address returned by `mmap`, the following offsets are used to access the clock fields:

0x0	upper 32-bits of tick clock
0x8	lower 32-bits of tick clock
0x10	status and control (cannot be modified)
0x100	POSIX clock seconds
0x108	POSIX clock nanoseconds
0x110	status and control (cannot be modified)

These offsets are defined in the header file `/usr/include/linux.h` (with names beginning with `RCIM_SYNCCLOCK_`).

To set the value of the POSIX clock, the `rcim_clocksync(1)` utility can be used in interactive mode using the “update” command.

## Synchronizing the Clocks

The sections below describe the techniques and tools used to synchronize the clocks on the RCIM.

### The `rcim_clocksync` Utility

The `rcim_clocksync(1)` utility can be used to reset the tick clocks on all connected RCIMs to zero to provide a common time stamp across the system. This synchronization operation occurs automatically when the RCIM master system boots. As slave systems become available, it will be necessary to reissue this command to synchronize the tick clocks across the RCIM chain, however, this can be automated (see the section “Automatic Synchronization” below). `rcim_clocksync` can also be used to synchronize the POSIX clocks on all connected RCIMs. This procedure is described in the section “Synchronizing the POSIX Clock.”

Note that the system clock is synchronized with the RCIM and when `rcim_clocksync` is run other than at system boot, there are consequences and should be used with caution. On RCIM III and RCIM II, master and slave system times are synchronized with the POSIX clock; on RCIM I, the times are synchronized with the tick clock. When system time stops advancing, time-based functions using those clocks will stop.

Synchronization always succeeds on the RCIM master or isolated system; an error is returned if synchronization is attempted on an RCIM slave system.

Specifying `rcim_clocksync` with no options on the RCIM master system synchronizes all tick clocks in the RCIM chain.

**rcim\_clocksync** takes the following options:

- i** interactive mode (see below)
- m** prints the configured hostname where the RCIM master is located (see “Configuration” in Chapter 2).
- s** prints the RCIM connection state
- devname** The device name of the desired RCIM board. Defaults to /dev/rcim0/rcim which is the first RCIM board that was found on boot. /dev/rcim1/rcim, /dev/rcim2/rcim, etc. should be used to point this tool to the second, third, etc. RCIM board found on boot.

When interactive mode is invoked, a display similar to the following example provides configuration and status information updated every two seconds, as well as command usage. These items are explained below.

```

RCIM is isolated          RCIM version: 1
Configured RCIM master hostname is Not_Configured

Clock status and values ...
cable signal : ENABLED
tick timer   : CABLE_ENABLE LOCAL_ENABLE
posix clock  : CABLE_ENABLE LOCAL_ENABLE
tick timer   :      10.3361 seconds (      25840213 ticks)
posix clock  :      18665.4696 seconds

operations are:
s           - synchronize clocks
0[tp]      - stop clock ([t]ick/[p]osix)
1[tp]      - start clock ([t]ick/[p]osix)
w[tp]      - update clock value ([t]ick/[p]osix)
i[tp]      - isolate clock ([t]ick/[p]osix)
c[tp]      - connect clock ([t]ick/[p]osix)
d           - disable cable clock signal
e           - enable cable clock signal
q           - quit

enter operation:

```

**RCIM is** indicates the RCIM mode for this system: master, pass-through slave, final slave or isolated

**RCIM version** is the RCIM version number

**Configured RCIM master hostname is** indicates the hostname of the RCIM master. This must be configured using the host configuration option (see “Configuration” in Chapter 2)

**cable signal** is one of the following:  
 ENABLED/DISABLED – For the RCIM master, indicates if the cable clock signal is being propagated to slaves. For RCIM slaves, indicates if clocks are being driven by the RCIM master or if ticking locally (without synchronization).  
 CLOCK\_MISSING – Error condition indicating cable clock signal is not being properly propagated to slaves.  
 CLOCK\_STOPPED – Error condition indicating cable clock signal has been stopped.



Status: is one of the following:

tick timer  
 posix clock

CABLE\_SYNC – indicates that the RCIM slave clock is being driven by RCIM master cable clock signal, if available

CABLE\_ENABLE – indicates that the RCIM clock resets when RCIM master does a synchronization

LOCAL\_ENABLE – indicates that the clock is enabled

NO\_RESET\_WHEN\_DISABLED – indicates that the clock is not reset when disabled

Values: current clock values for each clock

tick timer  
 posix clock

operations are: This section is usage information for the interactive mode. At the `enter` operation: prompt, supply one of the operation codes to accomplish the task described for that operation. As noted, some operations require a designation for the clock to be operated on: `t` for the tick clock; `p` for the POSIX clock.

## Synchronizing the Tick Clock

When the RCIM master system boots, `rcim_clocksync` is executed, which resets all tick clocks in the RCIM chain to zero.

When an RCIM slave system boots after the master has booted, the tick clocks on the systems in the RCIM chain will be out of sync, unless automatic clock synchronization is configured (see the section “Automatic Synchronization” below). Invoking `rcim_clocksync` without options on the master RCIM system synchronizes all tick clocks in the RCIM chain. See the section “The `rcim_clocksync` Utility” and the `rcim_clocksync(1)` man page for more information about this utility.

## RCIM Masterclock Considerations

For RCIM II and III, the RCIM POSIX clock is the system masterclock. This means that system time continually looks at the RCIM’s POSIX clock and adjusts itself to match.

In previous releases of RedHawk, a broken or stopped RCIM would confuse and often lock up the system, however this is no longer the case. The RedHawk masterclock code now continually tests the RCIM POSIX clock for validity and pauses clock synchronization if problems are detected. This means that the two clocks, the RCIM POSIX clock and the system clock, become free-running. Once the RCIM POSIX clock again becomes valid clock synchronization is resumed.

In order for synchronization to resume, RedHawk must detect that both the system clock and the RCIM POSIX clock are incrementing, that each clock is incrementing at the correct rate, and that each clock has a value within approximately two seconds of the other. This latter condition is most easily achieved by executing a `clock_gettime(3)`, but other methods, as documented in `masterclock(5)`, are available that may be more suitable for specific situations.

## Synchronizing the POSIX Clock

The POSIX clocks tick synchronously but generally do not have the same clock values and should not be used as a common time stamp. They can be synchronized with the other

POSIX clocks in the RCIM chain so that they are consistent, if desired. For the RCIM III, run **rcimdate** on each slave; on return the slave's RCIM POSIX clocks will be synchronized with the master. For RCIM I and II use the following **rcim\_clocksync interactive mode** procedure defined below.

Note that this operation also synchronizes the RCIM tick clocks. Be aware that while performing this procedure, the system time stops and time-base functions will be affected.

1. Ensure that all POSIX clocks on all RCIM slave systems are connected using the **cp** command.
2. Disable the cable clock signal on the RCIM master system (using the **d** command). The POSIX clocks on all systems should stop ticking.
3. Update the time values of the POSIX clocks on each system to the same value (using the **wp** command).
4. Re-enable the cable clock signal on the RCIM master system (using the **e** command). All clocks should begin ticking.

On RCIM systems equipped with the optional GPS module, the POSIX clock can be synchronized to standard GPS time. Refer to the section "Using GPS for System Timekeeping" below for information.

## Automatic Synchronization

For the RCIM III, each slave system can be configured so that its POSIX clock will be automatically synchronized with that of the master on boot. To do this, uncomment either the `RCIMDATE=continuous` or `RCIMDATE=oneshot` line in `/etc/sysconfig/rcim` on the slave. Subsequently, each time the slave is booted it will run **rcimdate** either once or continuously. If it is run once then the slave's POSIX clock will match that of the master until such time as some application on the master executes a `clock_settime(3)` (this is usually done by **ntp** or **ptpd**). If **rcimdate** is run in continuous mode, then the slave will execute a `clock_settime(3)` within a few seconds of each `clock_settime(3)` occurring on the master.

The system can also be configured to automatically synchronize the tick clocks when an RCIM slave system is booted. This feature is disabled by default and should be used with caution. It causes the tick clock on all systems to be reset to zero when any system in the RCIM chain is booted, which may have an undesirable impact on processes using the tick clock during synchronization.

To set up automatic synchronization of tick clocks when a slave system is booted, create an empty file `/etc/sysconfig/rcim_clocksync` on the slave system. This activates the `/etc/init.d/rcim_clocksync` startup script, asking it to reset its RCIM board and (by default) also reset the slave RCIM boards. This uses **ssh(1)**, which must be set up to communicate between the slave and master systems.

## Using GPS for System Timekeeping

On RCIM systems equipped with the optional GPS module, the POSIX clock can be used for system time synchronized to standard GPS time. The NTP daemon is utilized and

treats the GPS receiver as a time server. For information about how to configure NTP for this support, see the section “ntp Configuration for GPS Support” in Chapter 2.

RedHawk Linux includes the RFC-2783 pulse per second (PPS) interface that synchronizes the system time to the GPS PPS interface. The POSIX clock register is captured on the on-time edge of the GPS PPS signal. This avoids the jitter which would be introduced if an interrupt was used to capture the error between the system time and the GPS time.

A dedicated serial interface, `/dev/rcim_uart`, is used by NTP to communicate with the GPS receiver. This symbolic link is pointed to the last RCIM found with a GPS. If another RCIM is to be used, the administrator must point this special device to the uart special device file of the desired RCIM to, for example, `/dev/rcim3/uart`.

Likewise, the device which will receive the GPS pulse per second must be pointed to by `/dev/refclock-0`. This symbolic link also points to the last RCIM found having a GPS. If that is not the GPS that is wanted, the administrator must point this symbolic link to, for example, `/dev/rcim3/gps`.

Tools such as `ntpq(1)` and `ntpd(1)` can be used for monitoring NTP activity. Other aids include various log files that can be added to `/etc/ntp.conf` if desired. Refer to the `ntpd(1)` man page and [www.ntp.org](http://www.ntp.org) for details.

## Interrupt Processing

One or more of the following modules is used for interrupt processing on the RCIM:

- **Edge-Triggered Interrupts (ETIs)** – An ETI allows you to use an external event to trigger an interrupt. Documentation for ETIs begins on page 3-12.
- **Real-Time Clocks (RTCs)** – An RTC allows you to set up a counter to trigger an interrupt. Documentation for RTCs begins on page 3-14.
- **External Output Interrupts** – An external output signal allows you to use any of the other signal processing modules as the source for an interrupt on an external device. Documentation for external output interrupts begins on page 3-15.
- **Programmable Interrupt Generators (PIGs)** – A PIG allows you to programmatically generate a signal that can be used to trigger interrupts. Documentation for PIGs begins on page 3-16.
- **Distributed Interrupts (DIs)** – Distributed interrupts allow you to distribute signals or interrupts across all systems connected using an RCIM chain. Documentation for DIs begins on page 3-17.

The sections that follow explain how the RCIM interrupts are processed.

## Interrupt Processing Logic

Interrupt requests, whether generated by the RCIM board or by a software request, are handled by the edge-triggered interrupts (ETIs) and the distributed interrupts (DIs). Figure 3-1 illustrates how each interrupt request is processed.

**Figure 3-1 Interrupt Processing Logic**

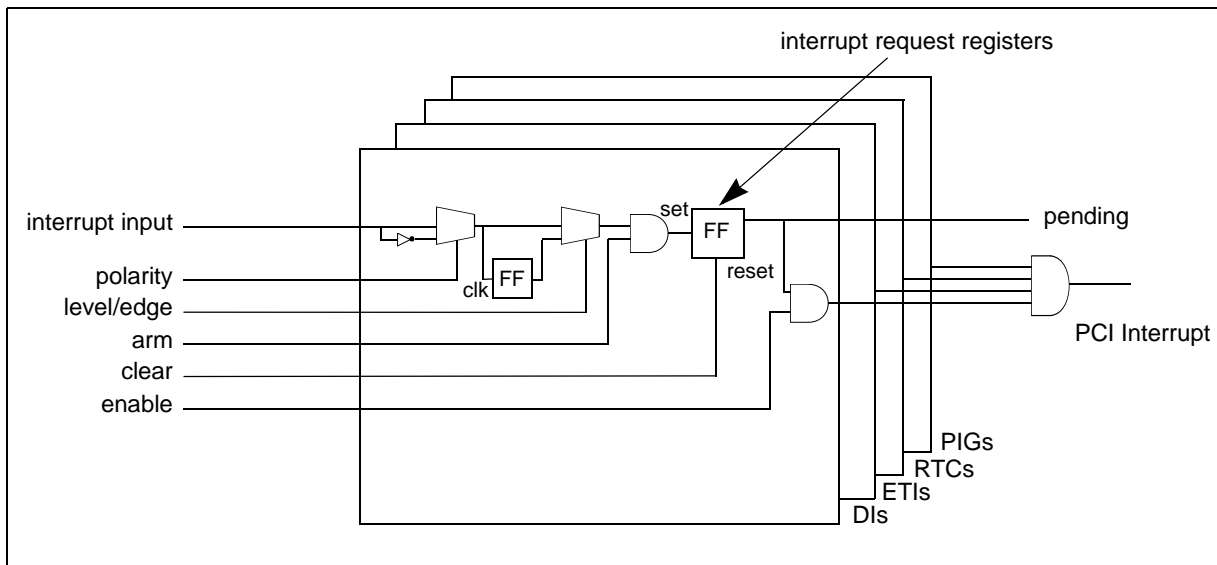

DIs and ETIs must be armed and enabled for an interrupt to occur. Each interrupt can be armed/disarmed and enabled/disabled individually. After power up initialization, all interrupts are disarmed and disabled.

When the interrupt is armed, interrupt requests set a request bit. When an interrupt is disarmed, any outstanding requests are turned off and ignored.

Requests for an enabled interrupt are allowed to enter the interrupt priority resolution logic. The enable bit may be thought of as granting the RCIM board permission to deliver any interrupt requests that it accepts. When the ETI or DI is disabled, it accepts interrupt requests, but delays delivering the interrupt until it is re-enabled.

On RCIM III and RCIM II, the input to the interrupt block is used to drive the DI. On RCIM I, the pending bit is the output of the ETI or DI. This output is routed to the host computer to which the RCIM board is attached, and additionally to other systems in the RCIM chain if configured to do so. The ETI or DI interrupt handler on the host clears the pending bit each time it concludes the processing of an interrupt. This clears the way for the RCIM board to output the next instance of this interrupt.

## Arming and Enabling DIs and ETIs

DIs and ETIs are armed using the `ioctl(2)` system call with the following operations, which can be used interchangeably:

```
DISTRIB_INTR_ARM
ETI_ARM
```

DIs and ETIs are enabled using `ioctl(2)` with the following operations, which can be used interchangeably:

```
DISTRIB_INTR_ENABLE
ETI_ENABLE
```

## Interrupt Recognition Logic

By default, the RCIM looks for the leading edge of an input signal to trigger an interrupt. Once the interrupt is recognized, it must be deasserted and reasserted to cause a new interrupt request. Optionally, an interrupt may be configured as level-sensitive. In this mode, an interrupt is triggered when the interrupt signal is high or low. Configuration options are included with the documentation for each type of interrupt later in this chapter.

For the RCIM to be able to reliably extract interrupts from an input signal, the equipment generating the signal must hold any value generated for at least 1.5 microseconds before transitioning to the reset value.

## Setting up Distributed Interrupts

The RCIM provides the ability to share interrupts across interconnected systems using an RCIM chain. Although distributed interrupts are covered in detail starting on page 3-17, the figures below provide an illustration of how they operate. Guidelines for setting up distributed interrupts based on the illustration follow.

**Figure 3-2 Distributed Interrupt Operation Example**

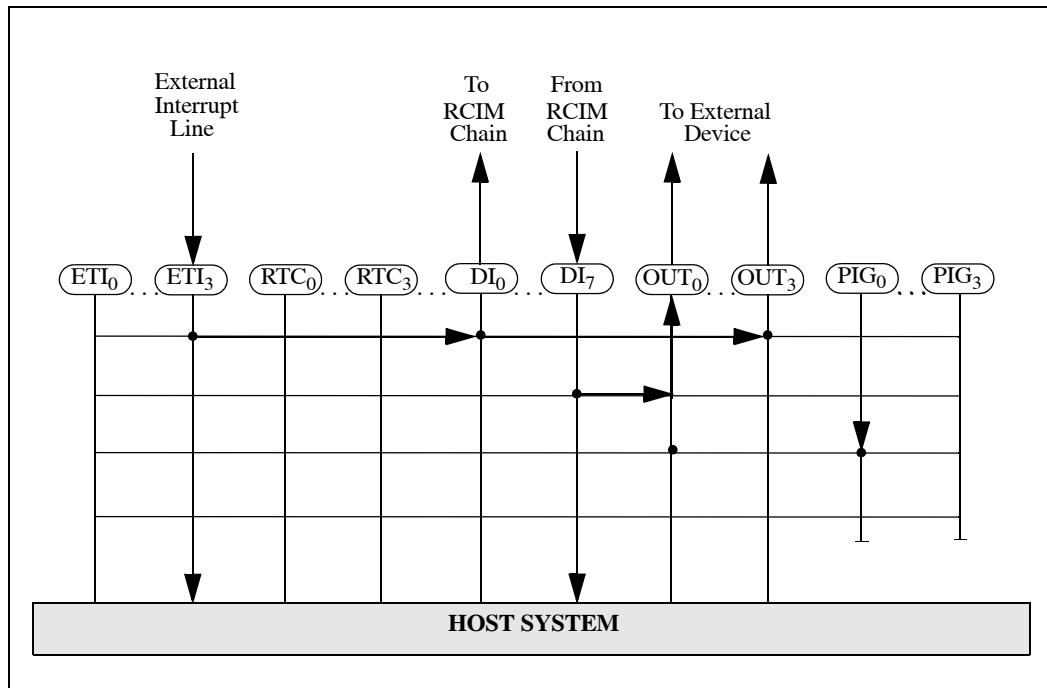

In Figure 3-2, there are three scenarios:

- A signal is generated on ETI<sub>3</sub> that drives an interrupt on DI<sub>0</sub> and another on OUT<sub>3</sub>. The interrupt is also passed to the host system.
- An interrupt is received from the RCIM chain on DI<sub>7</sub>. This interrupt is sent to the host system and also sent to an external device via OUT<sub>0</sub>.
- An interrupt is generated on PIG<sub>0</sub> that is passed to an external device via OUT<sub>0</sub>.

Note that on RCIM III and RCIM II, the local interrupt does not drive the configured DI. An ETI\_REQUEST ioctl will cause a local interrupt but will not affect the DI associated with the ETI. For example, if ETI<sub>0</sub> is configured to drive DI<sub>0</sub>, it will connect the external ETI input to DI<sub>0</sub> directly without passing through the local ETI<sub>0</sub> interrupt control logic. A benefit of this is that a local interrupt is not issued for every distributed PIG and ETI. A PIG should be used for a programmable software controlled interrupt and an ETI should be used for an external interrupt output.

Please note the following in this example:

- A problem can occur when more than one interrupt module tries to drive the same signal line. In the example, the ETI<sub>3</sub> signal drives the interrupt on

DI<sub>0</sub> and on OUT<sub>3</sub>. It is possible to configure another signal processing module (say RTC<sub>0</sub>) to drive the interrupts on DI<sub>0</sub> and OUT<sub>3</sub> at the same time. In this case, the signal that drives the line will be the one with the strongest amplifier. It is up to the administrator to avoid this condition.

- You determine which direction a distributed interrupt takes. This means that on a system where a distributed device resides, it may generate two interrupts: its local device interrupt (ETI, PIG or RTC) and the distributed interrupt. There is a separate interrupt vector for each.

It may be desirable to receive both interrupts, but generally only one is sufficient. By disarming the distributed interrupt, one can prevent that interrupt from being generated on the local system. By default, a distributed interrupt is in a disarmed state.

## Obtaining RCIM Values

There are several methods available for displaying or obtaining RCIM values:

`/proc/driver/rcimN` filesystem (where *N* starts from zero):

The following files in this filesystem can be viewed (read only unless noted otherwise):

**config** – the RCIM configuration in a form suitable to cut and paste (read/write)

**interrupts** – a count of all ETI, DI and RTC interrupts per CPU and in total

**status** – miscellaneous RCIM board status and time synchronization

**rawregs** – named hex display of all readable RCIM board registers

**rtc** – status of the RTCs (run status, count values, etc.)

**eti** – status of the ETIs (armed, enabled, etc.)

**di** – status of the DI lines (armed, enabled, etc.)

`ioctl(2)` system call:

Information about a specific interrupt type can be retrieved by specifying the appropriate operation with the appropriate device file `mmap`'d into the address space of the program; for example, `ETI_INFO` with `/dev/rcim0/eti1`. Refer to the `rcim_eti(4)`, `rcim_rtc(4)` and `rcim_distrib_intr(4)` man pages.

The `RCIM_GET_INFO` operation with the `/dev/rcim0/rcim` device file `mmap`'d provides the same information as `/proc/driver/rcim0/config`.

The `RCIM_GET_ADDR` operation with the `/dev/rcim0/rcim` device file `mmap`'d provides the virtual and physical address of the RCIM control registers.

The header file `/usr/include/rcim.h` describes the layout of the information returned by `RCIM_GET_INFO` and `RCIM_GET_ADDR`. Refer to the `rcim(4)` man page.

`mmap(2)` system call:

`mmap` can be used to map in some or all of the device registers of the RCIM board. The register layout is in `/usr/include/linux/rcim_ctl.h` and in Appendix A in this guide.

## Edge-Triggered Interrupts

Each RCIM board has incoming external interrupt lines, called ETIs or edge-triggered interrupts, so-named after their most common mode of operation. These lines permit users to provide their own interrupt sources. The RCIM processes and delivers these interrupts to the host system and, if they are distributed, routes and delivers them to all other RCIMs in the chain as distributed interrupts. RCIM III and RCIM II support twelve ETIs (0-11); RCIM I supports four ETIs (0-3).

Each ETI is independently configurable. An ETI may treat the incoming signal as an edge or level sensitive interrupt. If edge sensitive, it may raise an interrupt on either the rising or the falling edge. If level sensitive, it may raise interrupts for either the high or the low signal value. To specify how the incoming signal pattern is converted to interrupt requests, use one of the ETI configuration options described under "ETI Configuration".

Applications in turn arm or disarm, enable or disable each ETI on each system on the fly as appropriate to the needs of those applications.

One requirement the RCIM imposes on external signal generating equipment is that the signals they output must hold any low or high signal value for at least 1.5 microseconds before changing to the next state. Pulses of shorter duration may not be recognized by the interrupt controller. As long as the pulse is longer than 1.5 microseconds, the duration of the pulse is not important.

The `rcim_eti(4)` man page provides complete information about ETIs.

## ETI Configuration

Each edge-triggered interrupt can be configured to trigger on the rising or falling edge of a signal, or on a high or low signal value using the `eti` configuration option. This option has the following syntax:

```
etiN / [rising | falling | high | low]
```

The default setting for an ETI is "falling."

The flag words (`rising`, `falling`, `high`, `low`) can be specified using the first character of the word. These words are not case sensitive.

Examples include:

```
eti0/falling    sets ETI 0 to trigger on the falling edge of its input signal
eti1/r          sets ETI 1 to trigger on the rising edge of its input signal
eti2/h         sets ETI 2 to trigger on a high signal value
```

See the "Configuration" section in Chapter 2 or the `rcim(4)` man page for the various methods available for specifying configuration options.



## ETI Device Files

Each ETI is accessed through its own special device file:

```
/dev/rcimN/etiM
```

where *N* is the RCIM card number (starting from zero) and *M* is the ID of the ETI.

These files are created automatically on system boot by the `/etc/init.d/rcim` initialization script.

## User Interface to ETIs

An ETI is controlled by `open(2)`, `close(2)`, and `ioctl(2)` system calls. Note that this device does not support the `read(2)`, `write(2)` or `mmap(2)` system calls.

The `open` call assigns a file descriptor to one edge-triggered interrupt and verifies that the interrupt is not currently being used by another device driver. One device file exists for each edge-triggered interrupt. A `close` call frees the file descriptor and removes any attached signals. Refer to the man pages for more information.

The following commands to `ioctl` are used to manipulate the ETIs. These commands can also be applied to DIs. All `ioctl` calls use the constants defined in `/usr/include/rcim.h`. Refer to the `rcim_eti(4)` man page for more information.

<code>ETI_ARM</code>	arms the ETI
<code>ETI_DISARM</code>	disarms the ETI
<code>ETI_ENABLE</code>	enables the ETI
<code>ETI_DISABLE</code>	disables the ETI
<code>ETI_REQUEST</code>	generates a software requested interrupt
<code>ETI_INFO</code>	gets information about the ETI
<code>ETI_WAIT</code>	causes the process to sleep
<code>ETI_WAKEUP</code>	wakes all sleeping processes
<code>ETI_GETICNT</code>	returns the number of times this ETI has fired
<code>ETI_KEEPLIVE</code>	sets or clears the keepalive state
<code>ETI_VECTOR</code>	gets the interrupt vector associated with ETI
<code>IOCTLGETICNT</code>	returns the number of times this ETI has fired (generic)
<code>IOCTLKEEPLIVE</code>	sets or clears the keepalive state (generic)
<code>IOCTLVECNUM</code>	sets the interrupt vector associated with ETI (generic)
<code>IOCTLSIGATTACH</code>	requests a signal when an RCIM device generates an interrupt

Note that like DIs, an ETI must be armed and enabled before an interrupt can be received.

## Distributed ETIs

Any or all of the ETIs on an RCIM can be distributed to all systems connected by an RCIM chain. The source of a distributed ETI can be located on any of the RCIMs in the chain.

To determine if a specified ETI has its interrupts sent to all connected systems, use one of the methods described in the section entitled "Obtaining RCIM Values" on page 3-11. See the "Distributed Interrupts" section on page 3-17 for information about setting up distributed interrupts.

## Real-Time Clocks (RTCs)

The RCIM provides real-time clock timers. Each of these counters is accessible using a special file and each can be used for almost any timing or frequency control function. RCIM III and RCIM II support eight 32-bit RTCs (0-7); RCIM I supports four (0-3).

The real-time clock timers are programmable to several different resolutions which, when combined with a clock count value, provide a variety of timing intervals. This makes them ideal for running processes at a given frequency (e.g., 600Hz) or for timing code segments. The timers may be one-shot or periodic; if periodic, the original load value is automatically reloaded into the counter each time zero is reached.

In addition to being able to generate an interrupt on the host system, the output of an RCIM real-time counter can be distributed to other RCIM boards for delivery to their corresponding host systems, or delivered to external equipment attached to one of the RCIM's external output interrupt lines.

The `rcim_rtc(4)` man page provides complete information about RTCs.

## RTC Device Files

Each RTC is accessed through its own special device file:

```
/dev/rcimN/rtcM
```

where *N* is the RCIM card number (starting from zero) and *M* is the ID of the RTC.

These files are created automatically on system boot by the `/etc/init.d/rcim` initialization script.

## Distributed RTCs

Any or all of the RTCs on an RCIM can be distributed to all systems connected by an RCIM chain. The source of a distributed RTC may be located on any of the RCIMs in the chain.

To determine if a specified RTC has its interrupts sent to all connected systems, use one of the methods described in the section entitled "Obtaining RCIM Values" earlier in this chapter. See the "Distributed Interrupts" section on page 3-17 for information about setting up distributed interrupts.

## User Interface to RTCs

A real-time clock timer is controlled by `open(2)`, `close(2)`, and `ioctl(2)` system calls. The `close` system call, if it closes the last open to the device, stops the RTC and clears its settings unless the `IOCTLKEEPALIVE` `ioctl` command was issued to the RTC before the `close`.

The parameters passed through `ioctl` control the modes of the real-time clock timer, the clock count value, and counting itself, as well as getting the current settings of the RTC. This device does not support the `read(2)` and `write(1)` system calls.

The following commands to `ioctl` are used to manipulate the RTCs. All `ioctl` calls use the constants defined in `/usr/include/rcim.h`. Refer to the `rcim_rtc(4)` man page for further information.

<code>RTCIOCSETL</code>	initializes RTC values (32-bit interface)
<code>RTCIOCGETL</code>	retrieves RTC values (32-bit interface)
<code>RTCIOCSET</code>	initializes RTC values (16-bit interface)
<code>RTCIOCGET</code>	retrieves RTC values (16-bit interface)
<code>RTCIOCSETCNT</code>	sets RTC clock count
<code>RTCIOCMODCNT</code>	modifies RTC clock count
<code>RTCIOCGETCNT</code>	gets RTC clock count
<code>RTCIOCRES</code>	gets RTC clock resolution
<code>RTCIOCSTART</code>	starts RTC counting
<code>RTCIOCSTOP</code>	stops RTC counting
<code>RTCIOCWAIT</code>	blocks until RTC clock count reaches zero
<code>RTCIOCWAKEUP</code>	wakes all sleeping processes
<code>RTCIOCINFO</code>	gets information about RTC
<code>IOCTLGETCNT</code>	returns the number of times this clock has fired
<code>IOCTLVECNUM</code>	sets interrupt vector for RTC
<code>IOCTLKEEPALIVE</code>	does not destroy the timer on final close
<code>IOCTLSIGATTACH</code>	requests a signal when this RTC generates an interrupt

## External Output Interrupts

Each RCIM provides external output signals. These signals can be used as interrupt sources for other machines or used as signals to control external devices. RCIM III and RCIM II support twelve external output interrupts (0-11); RCIM I supports four (0-3).

The external output interrupts can be driven from one of several sources internal to the RCIM. The most common source is from the programmable interrupt generators (PIGs). PIGs provide full software control for generation of the output signals.

The pin-outs for the external interrupt connectors are described in Chapter 2.

## Configuration

Each external output line can be configured to be driven by a specified source using the following configuration option:

```
<source> | outN
```

The value specified for the source can be one of the following:

<b>rtcN</b>	real-time clock timers
<b>pigN</b>	programmable interrupt generators
<b>etiN</b>	edge triggered interrupts
<b>diN</b>	distributed interrupts
<b>none</b>	let the interrupt output line float

Examples include:

```
rtc3|out0      sets output line 0 to be driven by real-time clock 3
di5|out2      sets output line 2 to be driven by distributed interrupt 5
```

Defaults for this configuration option are a PIG as source for the corresponding output line; i.e.:

```
pig0|out0
pig1|out1
etc.
```

See the “Configuration” section in Chapter 2 or the `rcim(4)` man page for the various methods available for specifying configuration options.

## Programmable Interrupt Generators (PIGs)

Each RCIM provides programmable interrupt generators (PIGs). PIGs are generally used to provide software control for the output of an external output signal. Additionally, the PIGs can be used to drive a signal onto a distributed interrupt line, permitting user software to generate distributed interrupts that are simultaneously delivered to all RCIMs in an RCIM chain. RCIM III and RCIM II support twelve PIGs (0-11); RCIM I supports four PIGs (0-3).

The `rcim_pig(4)` man page provides complete information about PIGs.

## PIG Device File

The device file `/dev/rcimN/pig` is used to access the PIG register on the local system. This file must be mapped into the address space of a program using `mmap(2)`. By default, only users with root privileges have access to do this.

On RCIM III and RCIM II, the PIG register is 12 bits wide, one bit for each PIG. Two additional registers allow the PIG bits to be set and cleared in a multiprocessor safe manner. In the `mmap`'ed PIG register page, the set register (PIGS) is at offset 0x10 and the clear register (PIGC) is at offset 0x20. Setting a PIG generates a distributed interrupt or

external output, depending on how the PIGs are connected. The required length of the signal depends upon the requirements of the attached device. If the signal is being fed into another RCIM, it must hold any low or high value for at least 1.5 microseconds before changing to the next state.

On RCIM I, the PIG register is a 32-bit register, one bit for each PIG. PIG 0 is controlled by bit 0 (the least significant bit), PIG 1 by bit 1, etc. The remaining bits are unused. Writing a value to the bit corresponding to a PIG causes the inverted signal value to be emitted from the PIG RCIM signal generator. This can be used to control external devices or generate distributed interrupts, depending on how the PIGs are connected. The required length of the signal depends upon the requirements of the attached device. If the signal is being fed into another RCIM, it must hold any low or high value for at least 1.5 microseconds before changing to the next state.

## Distributed PIGs

Any or all of the PIGs on an RCIM can be distributed to all systems connected by an RCIM chain. The source of a distributed PIG may be located on any of the RCIMs in the chain.

To determine if a specified PIG has its interrupts sent to all connected systems, use one of the methods described in the section entitled “Obtaining RCIM Values” earlier in this chapter. See the “Distributed Interrupts” section below for information about setting up distributed interrupts.

## Distributed Interrupts

The real heart and power of the RCIM lies in its distributed interrupt system. Each RCIM can distribute interrupts simultaneously to all systems connected via an RCIM chain. RCIM III and RCIM II support a total of twelve distributed interrupts (0-11); RCIM I supports a total of eight (0-7). A diagram of this functionality and guidelines for setting up distributed interrupts can be found in the section “Setting up Distributed Interrupts” earlier in this chapter.

Any of the edge-triggered interrupts, real-time clock timers or programmable interrupt generators on any of the RCIM boards in the chain can be configured to be distributed. A distributed device file is associated with each of the distributed interrupts.

RCIM distributed interrupts must be configured on each system attached to the RCIM that is either broadcasting or intending to receive a distributed interrupt. Distributed interrupts can also be configured and used locally on an isolated system. Configuration details are given in the “DI Configuration” section below. See the section “Obtaining RCIM Values” on page 3-11 for the methods available for obtaining configuration information.

The `rcim_distrib_intr(4)` man page provides complete information about DIs.

## DI Configuration

It is important that all RCIM-connected systems have a compatible configuration for the distributed interrupt lines of the RCIM.

By default, no distributed interrupts are configured.

Distributed interrupts must first have a source, and then can be configured to trigger on the rising or falling edge of a signal, or on a high or low signal value.

To define the source for a distributed interrupt, use the following configuration option:

```
<source> | diN
```

The value specified for the source can be one of the following:

<b>rtcN</b>	real-time clock timers
<b>pigN</b>	programmable interrupt generators
<b>etiN</b>	edge-triggered interrupts
<b>none</b>	the RCIM is not to drive this distributed interrupt

Examples include:

```
rtc3 | di6    sets distributed interrupt 6 to be driven by real-time clock 3
pig1 | di3    sets distributed interrupt 3 to be driven by programmable interrupt
              generator 1
none | di0    the RCIM is not to drive distributed interrupt 0
```

Each distributed interrupt can be configured to trigger on the rising or falling edge of a signal, or on a high or low signal value using the **di** configuration option. This option has the following syntax:

```
diN/[rising|falling|high|low]
```

The flag words (*rising*, *falling*, *high*, *low*) can be specified using the first character of the word. These words are not case sensitive.

Examples include:

```
di0/falling  sets distributed interrupt 0 to trigger on the falling edge of its input
              signal
di1/r        sets distributed interrupt 1 to trigger on the rising edge of its input
              signal
```

See the “Configuration” section in Chapter 2 or the **rcim(4)** man page for the various methods available for specifying configuration options.

## DI Device Files

Each distributed interrupt is accessed through its own special device file:

```
/dev/rcimN/diM
```

where *N* is the RCIM card number (starting from zero) and *M* is the ID of the distributed interrupt.

These files are created automatically on system boot by the `/etc/init.d/rcim` initialization script.

## User Interface to DIs

A distributed interrupt is controlled by `open(2)`, `close(2)`, and `ioctl(2)` system calls. Note that this device does not support the `read(2)`, `write(2)` and `mmap(2)` system calls.

The `open` call assigns a file descriptor to one distributed interrupt. A `close` call frees the file descriptor and, if it is the last close, disarms the interrupt if the `IOCTLKEEPALIVE` state is clear. Refer to the man pages for more information.

The following commands to `ioctl` are used to manipulate distributed interrupts. These commands can also be applied to ETIs. All `ioctl` calls use the constants defined in `/usr/include/rcim.h`. Refer to the `rcim_distrib_intr(4)` man page for more information.

<code>DISTRIB_INTR_ARM</code>	arms the DI
<code>DISTRIB_INTR_DISARM</code>	disarms the DI
<code>DISTRIB_INTR_ENABLE</code>	enables the DI
<code>DISTRIB_INTR_DISABLE</code>	disables the DI
<code>DISTRIB_INTR_REQUEST</code>	generates a software requested interrupt
<code>DISTRIB_INTR_INFO</code>	gets information about the DI
<code>DISTRIB_INTR_WAIT</code>	sleeps until the next DI
<code>DISTRIB_INTR_WAKEUP</code>	wakes up all sleeping processes
<code>DISTRIB_INTR_KEEPALIVE</code>	sets or clears keepalive state
<code>DISTRIB_INTR_GETICNT</code>	returns the number of times this DI has fired
<code>DISTRIB_INTR_VECTOR</code>	gets interrupt vector for the DI
<code>IOCTLKEEPALIVE</code>	sets or clears keepalive state (generic)
<code>IOCTLGETICNT</code>	returns the number of times this DI has fired (generic)
<code>IOCTLVECNUM</code>	sets interrupt vector for the DI (generic)
<code>IOCTLSIGATTACH</code>	requests a signal when an RCIM device generates an interrupt

Note that like ETIs, a distributed interrupt must be armed and enabled before an interrupt can be received.





# A Registers

This appendix describes the registers on the RCIM boards.

## RCIM III Registers

This section contains the address map and registers on the RCIM III board.

### RCIM III Address Map

Address	Function
0xXXXX0000	Board Status/Control Register (BSCR)
0xXXXX0004	FirmwareRev/OptionsPresentRegister (FWOP)
0xXXXX0010	Interrupt Enable Register #1 (IER1)
0xXXXX0014	Interrupt Enable Register #2 (IER2)
0xXXXX0020	Interrupt Request Register #1 (IRR1) (Write Only)
0xXXXX0024	Interrupt Request Register #2 (IRR2) (Write Only)
0xXXXX0020	Interrupt Pending Register #1 (IPR1) (Read Only)
0xXXXX0024	Interrupt Pending Register #2 (IPR2) (Read Only)
0xXXXX0030	Interrupt Clear Register #1 (ICR1)
0xXXXX0034	Interrupt Clear Register #2 (ICR2)
0xXXXX0040	Interrupt Arm Register #1 (IAR1)
0xXXXX0044	Interrupt Arm Register #2 (IAR2)
0xXXXX0050	Interrupt Select Level Register #1 (ISLR1)
0xXXXX0054	Interrupt Select Level Register #2 (ISLR2)
0xXXXX0060	Interrupt Select Polarity Register #1 (ISPR1)
0xXXXX0064	Interrupt Select Polarity Register #2 (ISPR2)
0xXXXX0070	External Interrupt Routing Register #1 (EIRR1)
0xXXXX0074	External Interrupt Routing Register #2 (EIRR2)
0xXXXX0078	External Interrupt Routing Register #3 (EIRR3)
0xXXXX0080	Cable Interrupt Routing Register #1 (CIRR1)
0xXXXX0084	Cable Interrupt Routing Register #2 (CIRR2)
0xXXXX0088	Cable Interrupt Routing Register #3 (CIRR3)
0xXXXX0200	PPS Snapshot Register (PPS) (Read Only)
0xXXXX0210	Cable Snapshot Register (CSR) (Read Only)
0xXXXX0220	Cable Master Time Register (CMTR) (Read Only)
0xXXXX0400	Clear Cable Errors (CCERR) (Write Only)
0xXXXX0410	Output Cable Status Register (OCSR) (Read Only)
0xXXXX0420	Input Cable Status Register (ICSR) (Read Only)
0xXXXX1000	Tick Clock Upper (TCU)
0xXXXX1008	Tick Clock Lower (TCL)

Address	Function	
0xXXXX1010	Tick Clock Status/Control	(TCSC)
0xXXXX1100	POSIX Clock Seconds	(PCS)
0xXXXX1108	POSIX Clock Nanoseconds	(PCN)
0xXXXX1110	POSIX Clock Status/Control	(PCSC)
0xXXXX1114	POSIX Clock Skip/Add Time	(PCSAT) (Write Only)
0xXXXX1120	Clock Frequency Adjust Register	(CFAR)
0xXXXX2000	RTC #0 Control	(RTC0C)
0xXXXX2010	RTC #0 Timer	(RTC0T)
0xXXXX2014	RTC #0 Repeat	(RTC0R)
0xXXXX2020	RTC #1 Control	(RTC1C)
0xXXXX2030	RTC #1 Timer	(RTC1T)
0xXXXX2034	RTC #1 Repeat	(RTC1R)
0xXXXX2040	RTC #2 Control	(RTC2C)
0xXXXX2050	RTC #2 Timer	(RTC2T)
0xXXXX2054	RTC #2 Repeat	(RTC2R)
0xXXXX2060	RTC #3 Control	(RTC3C)
0xXXXX2070	RTC #3 Timer	(RTC3T)
0xXXXX2074	RTC #3 Repeat	(RTC3R)
0xXXXX2080	RTC #4 Control	(RTC4C)
0xXXXX2090	RTC #4 Timer	(RTC4T)
0xXXXX2094	RTC #4 Repeat	(RTC4R)
0xXXXX20A0	RTC #5 Control	(RTC5C)
0xXXXX20B0	RTC #5 Timer	(RTC5T)
0xXXXX20B4	RTC #5 Repeat	(RTC5R)
0xXXXX20C0	RTC #6 Control	(RTC6C)
0xXXXX20D0	RTC #6 Timer	(RTC6T)
0xXXXX20D4	RTC #6 Repeat	(RTC6R)
0xXXXX20E0	RTC #7 Control	(RTC7C)
0xXXXX20F0	RTC #7 Timer	(RTC7T)
0xXXXX20F4	RTC #7 Repeat	(RTC7R)
0xXXXX3000	Programmable Interrupt Generator	(PIG)
0xXXXX3010	Programmable Interrupt Generator Set	(PIGS) (Write Only)
0xXXXX3020	ProgrammableInterruptGeneratorClear	(PIGC) (Write Only)
0xXXXX3100	SPI Count Register	(SCR)
0xXXXX3200	GPS Receive Pointers	(GRXP)
0xXXXX3204	GPS Transmit Pointers	(GTXP)
0xXXXX3208	GPS Debug Control Register	(GDCR)
0xXXXX320C	GPS Communication Error Register	(GCER)
0xXXXX3800- 0xXXXX3FFF	SPI Data Buffer	(SDB)
0xXXXX4000- 0xXXXX47FF	GPS Receive Data Buffer	(GRDB)
0xXXXX4800- 0xXXXX4FFF	GPS Transmit Data Buffer	(GTDB)

# RCIM III Registers

RCIM III registers are illustrated in this section.

**NOTE:** Unless otherwise stated, a bit value of 1=on; 0=off

**Figure A-1 RCIM III Board Status/Control Register (BSCR)**

This register provides status and control of certain features of the RCIM III board.

Offset: 0000

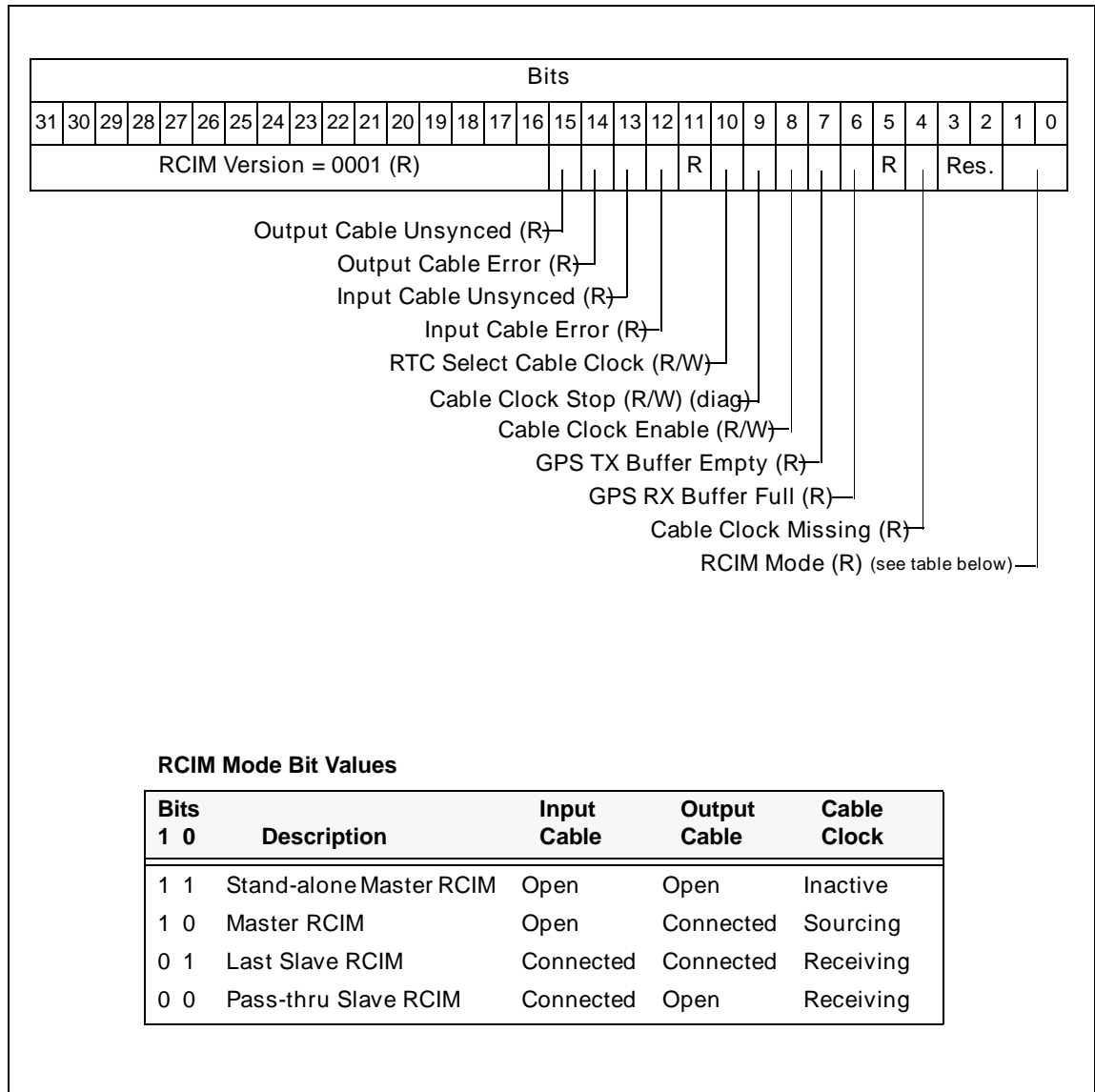

**Figure A-2 RCIM III Firmware Revision/Options Present Register (FWOP)**

This register provides information on what options are present on this RCIM board and the firmware revision.

Offset: 00004

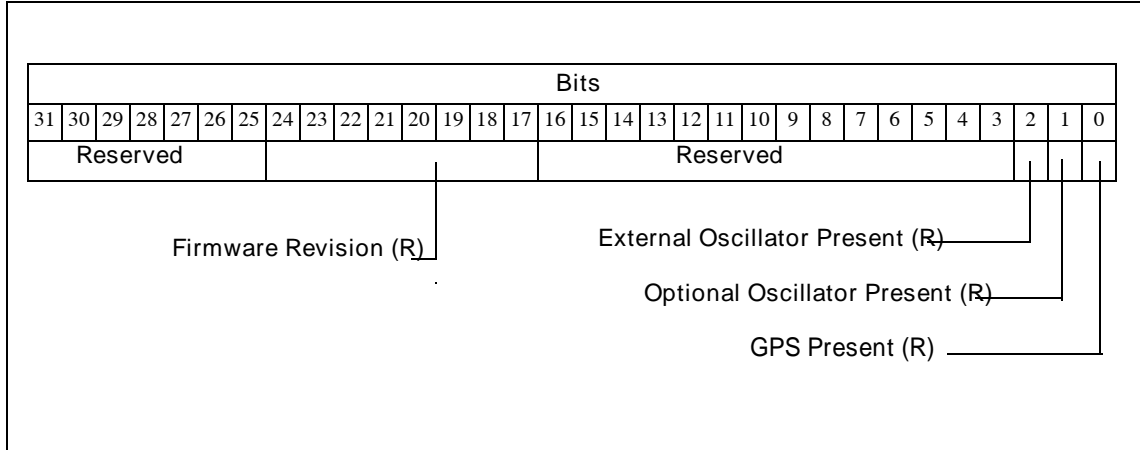

**Figure A-3 RCIM III Interrupt Enable/Request/Pending/Clear/Arm/Level/Polarity Registers (IER, IRR, IPR, ICR, IAR, ISLR, ISPR)**

The enable registers (IER) enable the selected interrupts.  
 The request registers (IRR) are software driven requests of the selected interrupts.  
 The pending registers (IPR) are pending requests.  
 The clear registers (ICR) clear the selected interrupts.  
 The arm registers (IAR) arm the selected interrupts for edge triggering.  
 The level registers (ISLR) set level (1) or edge (0) for the selected interrupts.  
 The polarity registers (ISPR) set polarity high (1) or low (0) for the selected interrupts.

Offsets: IER1: 0010, IER2: 0014, IRR1/IPR1: 0020, IRR2/IPR2: 0024, ICR1: 0030, ICR2: 0034,  
 IAR1: 0040, IAR2: 0044, ISLR1: 0050, ISLR2: 0054, ISPR1: 0060, ISPR2: 0064

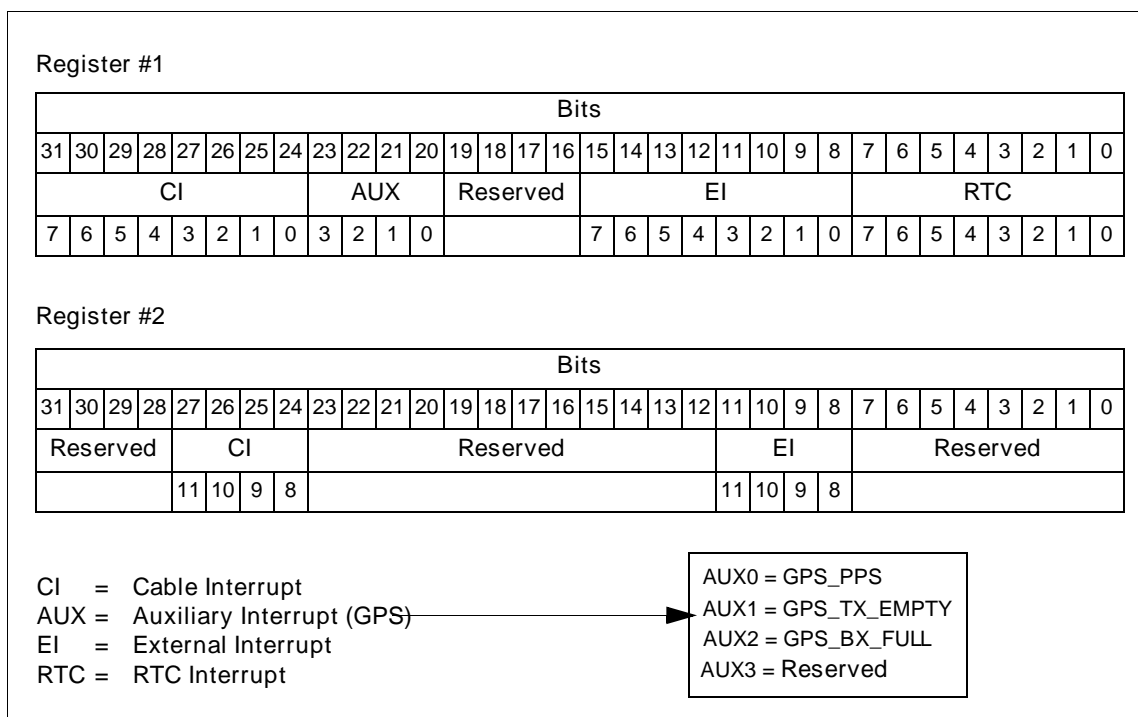

**Figure A-4 RCIM III External Interrupt Routing Registers (EIRR)**

The external interrupt routing registers route selected interrupts to the external interrupt connector.

Offset: EIRR1: 0070, EIRR2: 0074, EIRR3: 0078

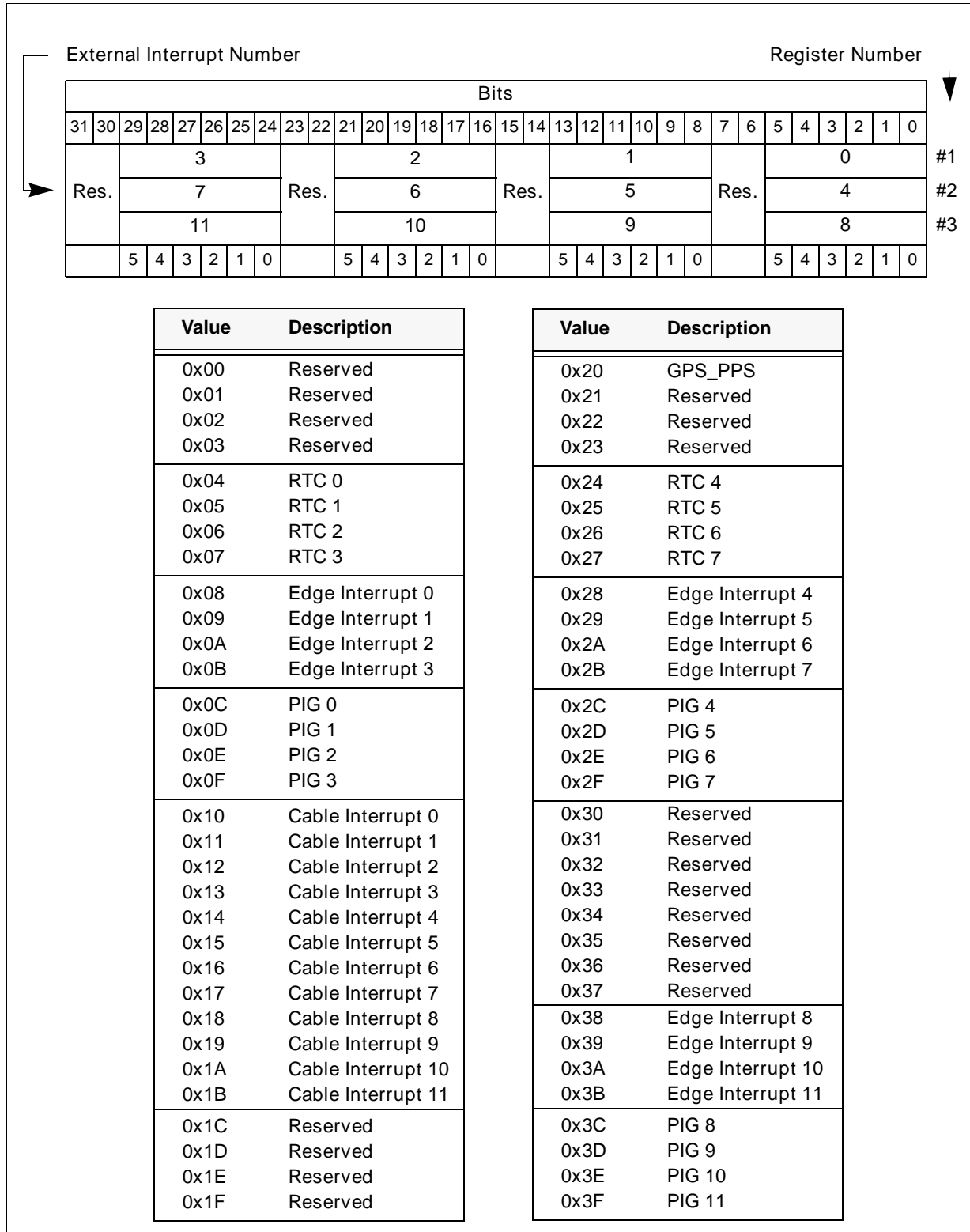

**Figure A-5 RCIM III Cable Interrupt Routing Registers (CIRR)**

The cable interrupt routing registers route selected interrupts to the RCIM interconnecting cable.

Offsets: CIRR1: 0080, CIRR2: 0084, CIRR3: 0088

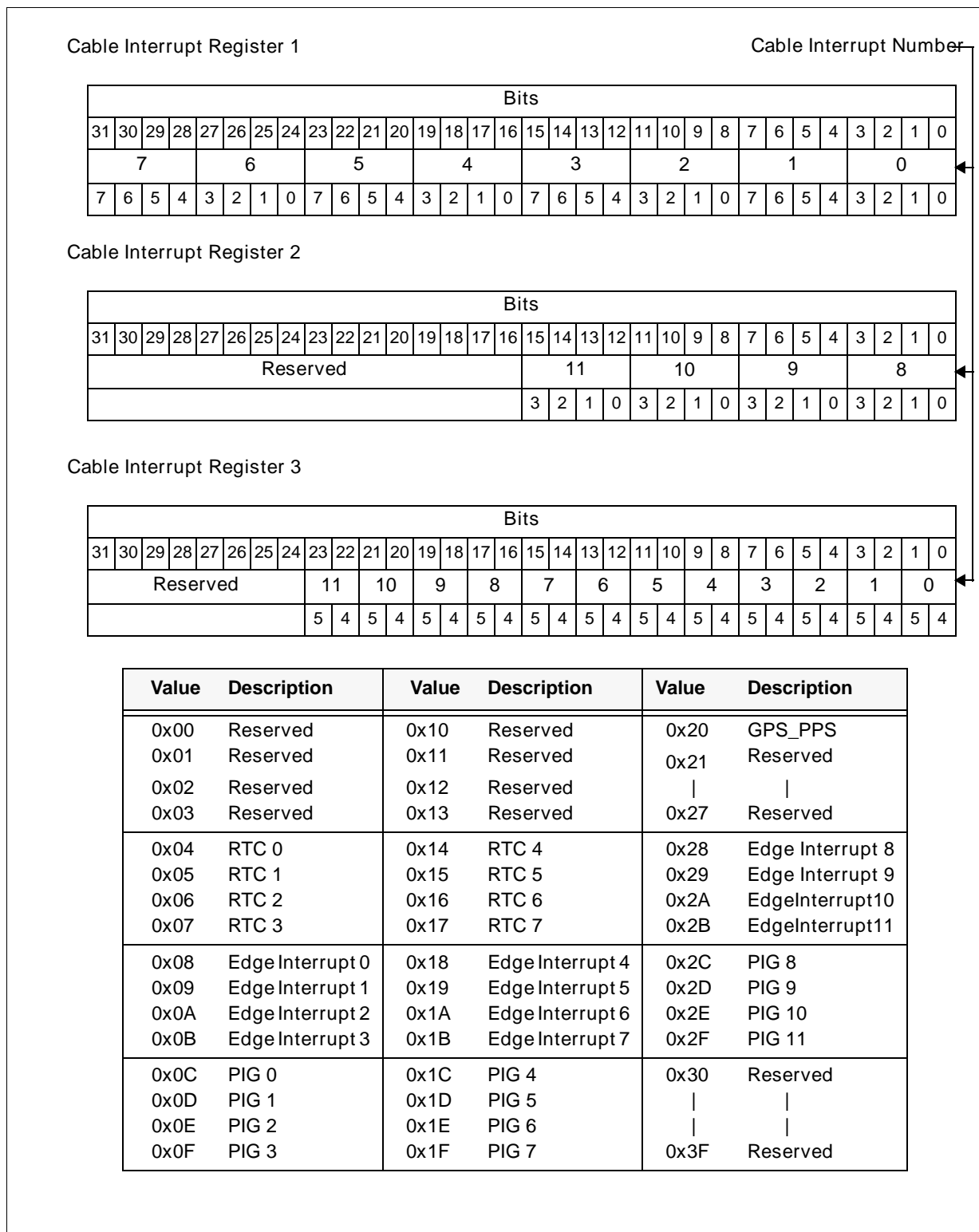

**Figure A-6 RCIM III PPS Snapshot Register (PPS)**

The PPS Snapshot register contains a snapshot of the nanoseconds field and two bits of the seconds field of the POSIX clock. The snapshot is taken every time the GPS PPS signal occurs.

Offset: 0200

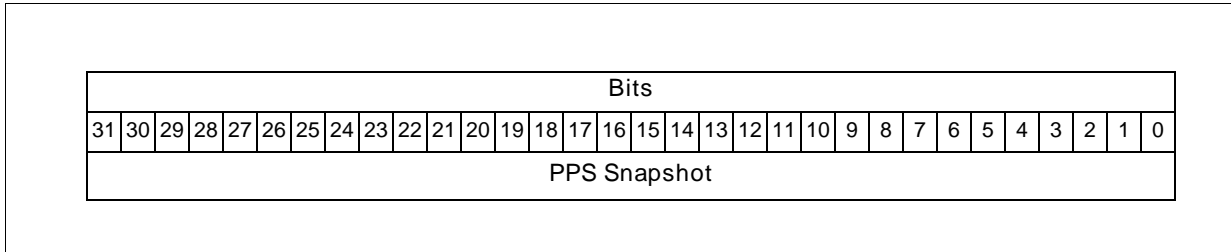

**Figure A-7 RCIM III Cable Snapshot Register (CSR)**

The Cable Snapshot register contains a snapshot of the nanoseconds field and two bits of the seconds field of the POSIX clock. The snapshot is taken every time the cable master time is received.

Offset: 0210

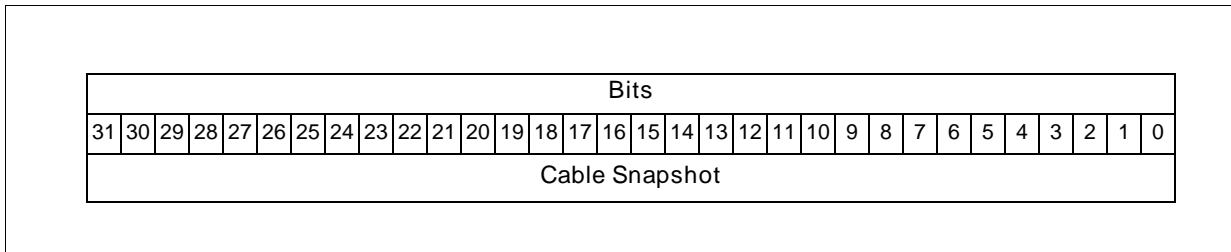

**Figure A-8 RCIM III Cable Master Time Register (CMTR)**

The Cable Master Time register contains the seconds field of the master RCIM POSIX clock that is transmitted on the cable at every transition of the clock at the seconds boundary.

Offset: 0220

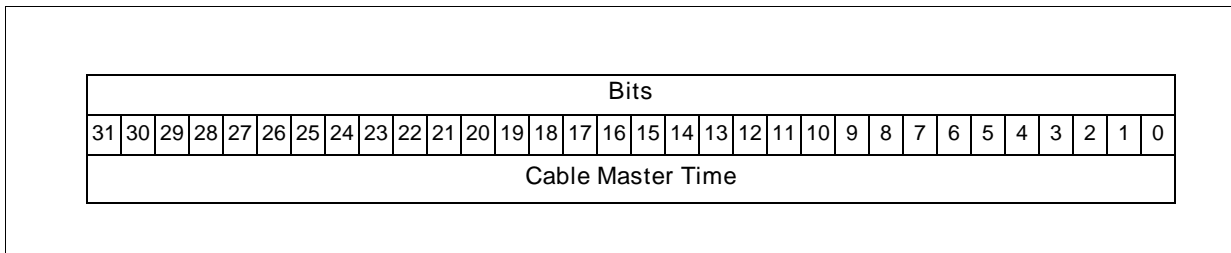
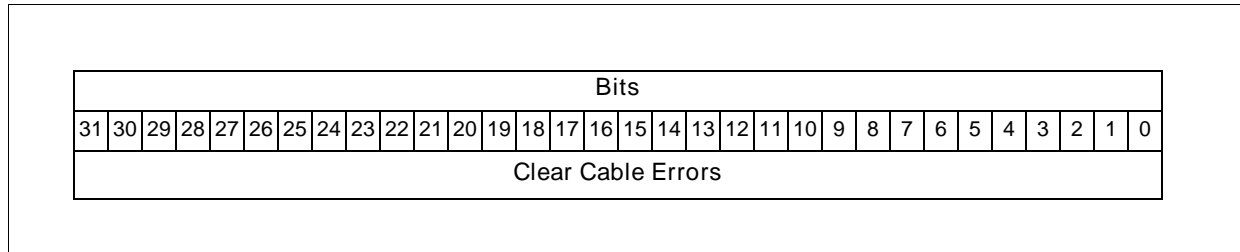



**Figure A-9 RCIM III Clear Cable Errors Register (CCERR)**

This is a Write Only register that clears any reported cable errors. The data field is don't care.

Offset: 0400



**Figure A-10 RCIM III Output Cable Status Register (OCSR)**

This register provides detailed hardware status information pertaining to the output cable.

Offset: 0410

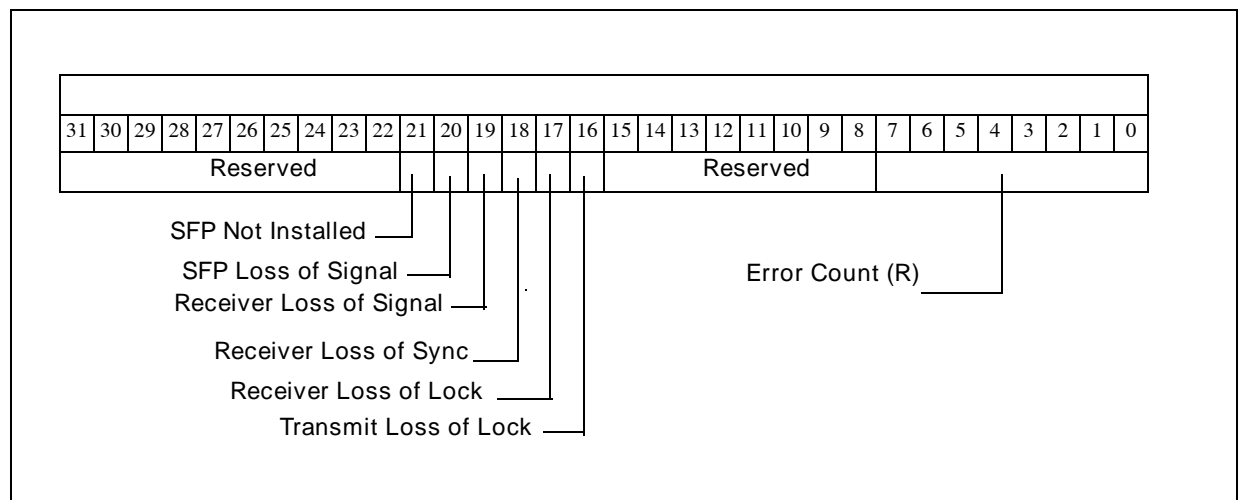

**Figure A-11 RCIM III Input Cable Status Register (ICSR)**

This register provides detailed hardware status information pertaining to the input cable.

Offset: 0420

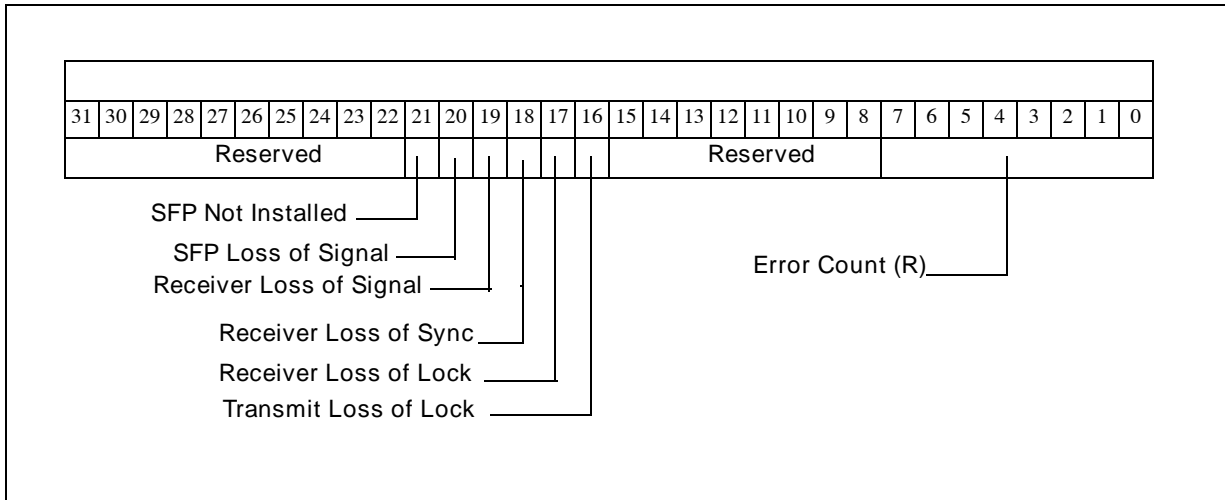

**Figure A-12 RCIM III Tick Clock Upper Register (TCU)**

This register contains the upper 32 bits of the tick clock.

Offset: 1000

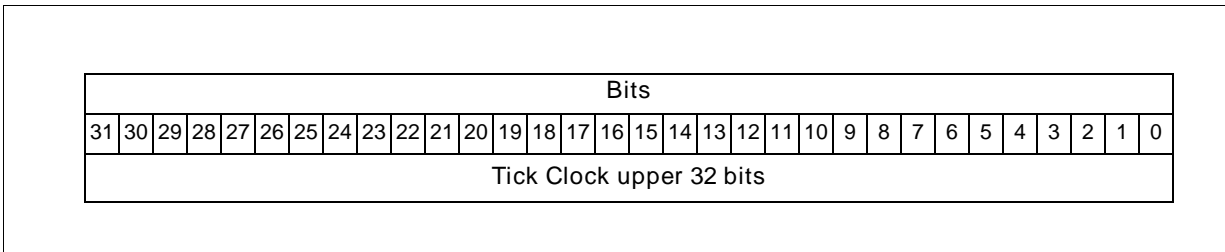

**Figure A-13 RCIM III Tick Clock Lower Register (TCL)**

This register contains the lower 32 bits of the tick clock.

Offset: 1008

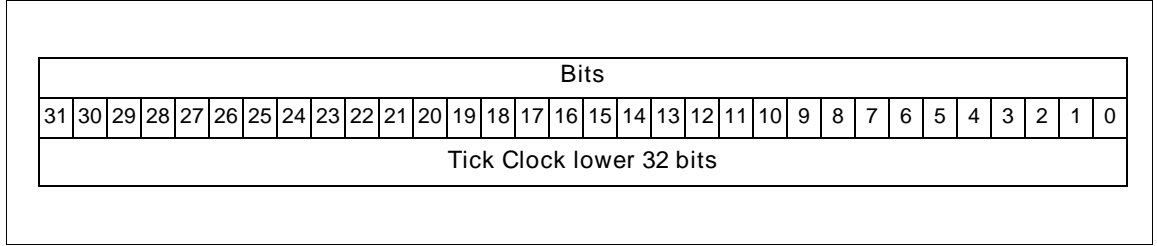

**Figure A-14 RCIM III Tick Clock Status/Control Register (TCSC)**

This register provides status and control of the tick clock.

Offset: 1010

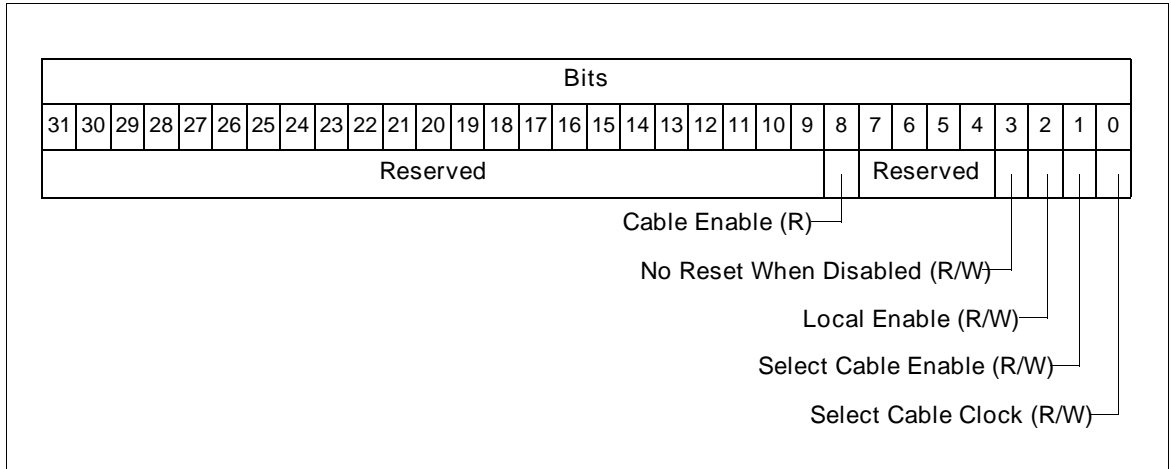

**Figure A-15 RCIM III POSIX Clock Seconds Register (PCS)**

This register contains the POSIX clock seconds.

Offset: 1100

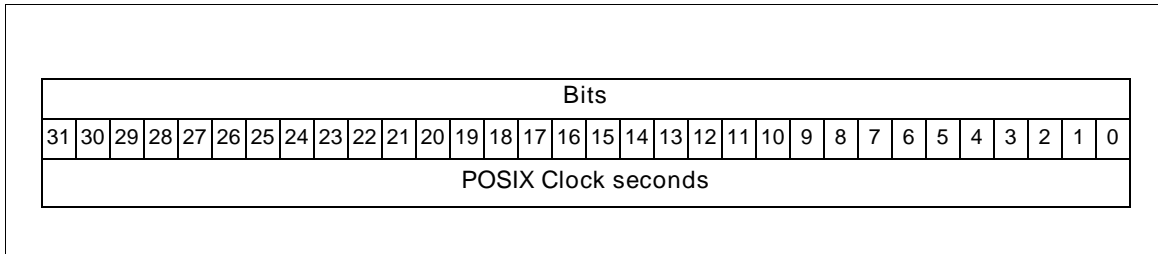

**Figure A-16 RCIM III POSIX Clock Nanoseconds Register (PCN)**

This register contains the POSIX clock nanoseconds.

Offset: 1108

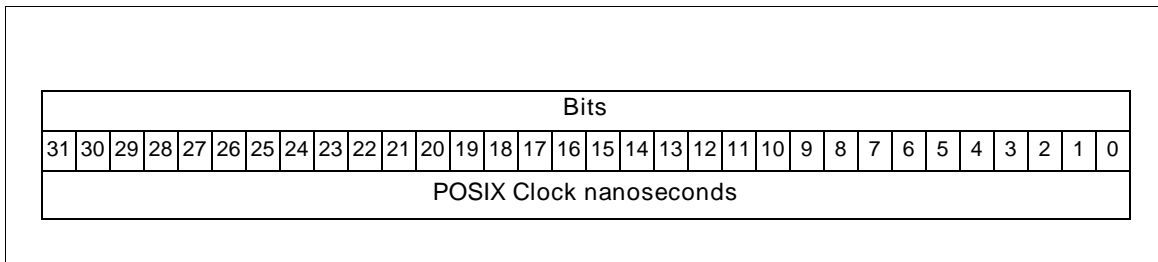

**Figure A-17 RCIM III POSIX Clock Status/Control Register (PCSC)**

This register provides status and control of the POSIX clock.

Offset: 1110

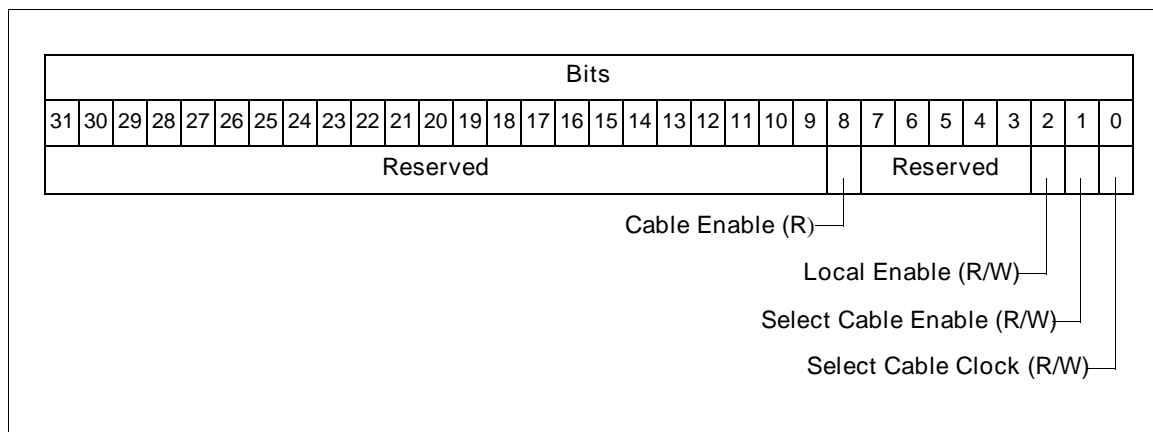
**Figure A-18 RCIM III POSIX Clock Skip/Add Time Register (PCSAT)**

This register skips/adds time to the POSIX clock in 400 nanosecond increments.

Offset: 1114

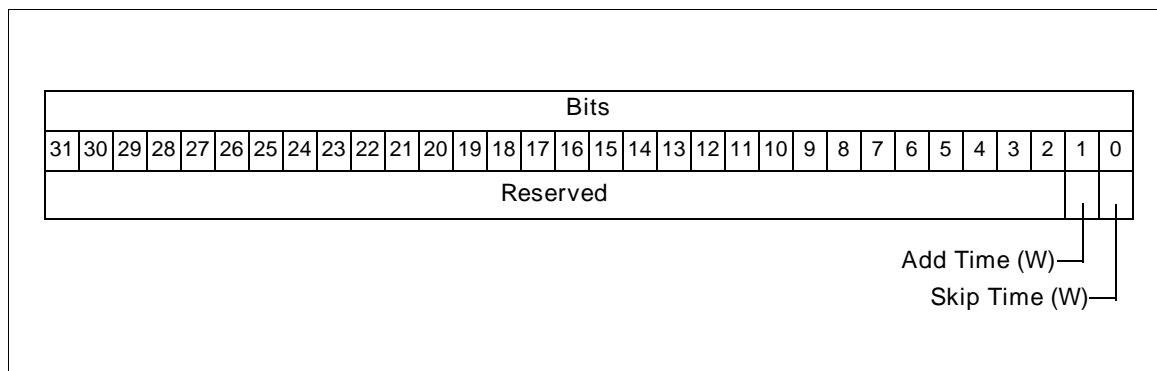

**Figure A-19 RCIM III Clock Frequency Adjust Register (CFAR)**

The clock frequency adjust register is used to control the frequency of the 10 Mhz master clock.

Offset: 1120

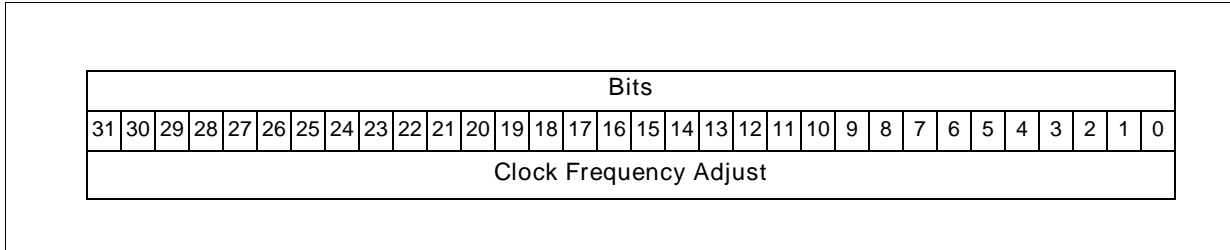

**Figure A-20 RCIM III RTC Timer Registers (RTCT)**

The initial RTC timer value is loaded in the RTC timer registers. The current value of the timer is read from this register. NOTE: Loading this register also loads the RTC Repeat Register for compatibility with RCIM.

Offsets: RTC0T: 2010, RTC1T: 2030, RTC2T: 2050, RTC3T: 2070, RTC4T: 2090, RTC5T: 20B0,  
 RTC6T: 20D0, RTC7T: 20F0

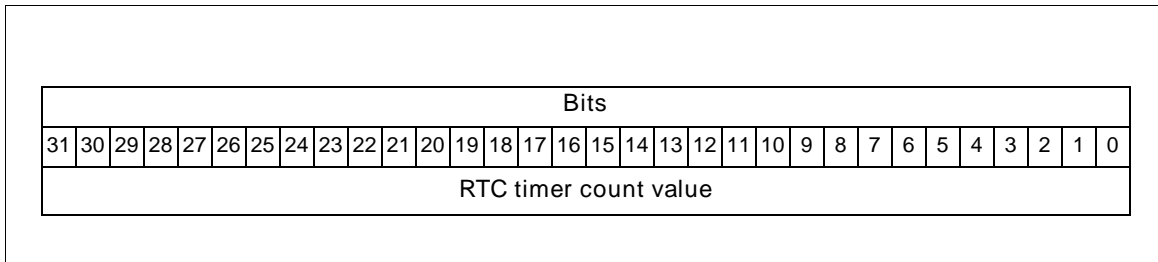

**Figure A-21 RCIM III RTC Repeat Registers (RTCR)**

The RTC repeat registers contain the repeat count value.

Offsets: RTC0R: 2014, RTC1R: 2034, RTC2R: 2054, RTC3R: 2074, RTC4R: 2094, RTC5R: 20B4,  
 RTC6R: 20D4, RTC7R: 20F4

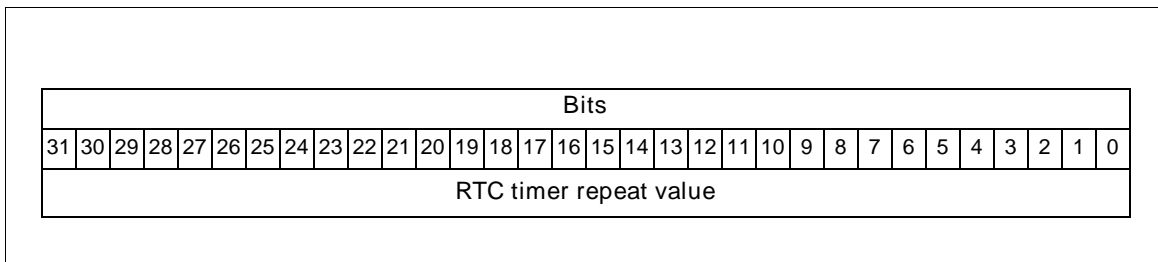

**Figure A-22 RCIM III RTC Control Registers (RTCC)**

This register provides control of the RTCs.

Offsets: RTC0C: 2000, RTC1C: 2020, RTC2C: 2040, RTC3C: 2060, RTC4C: 2080, RTC5C: 20A0,  
RTC6C: 20C0, RTC7C: 20E0

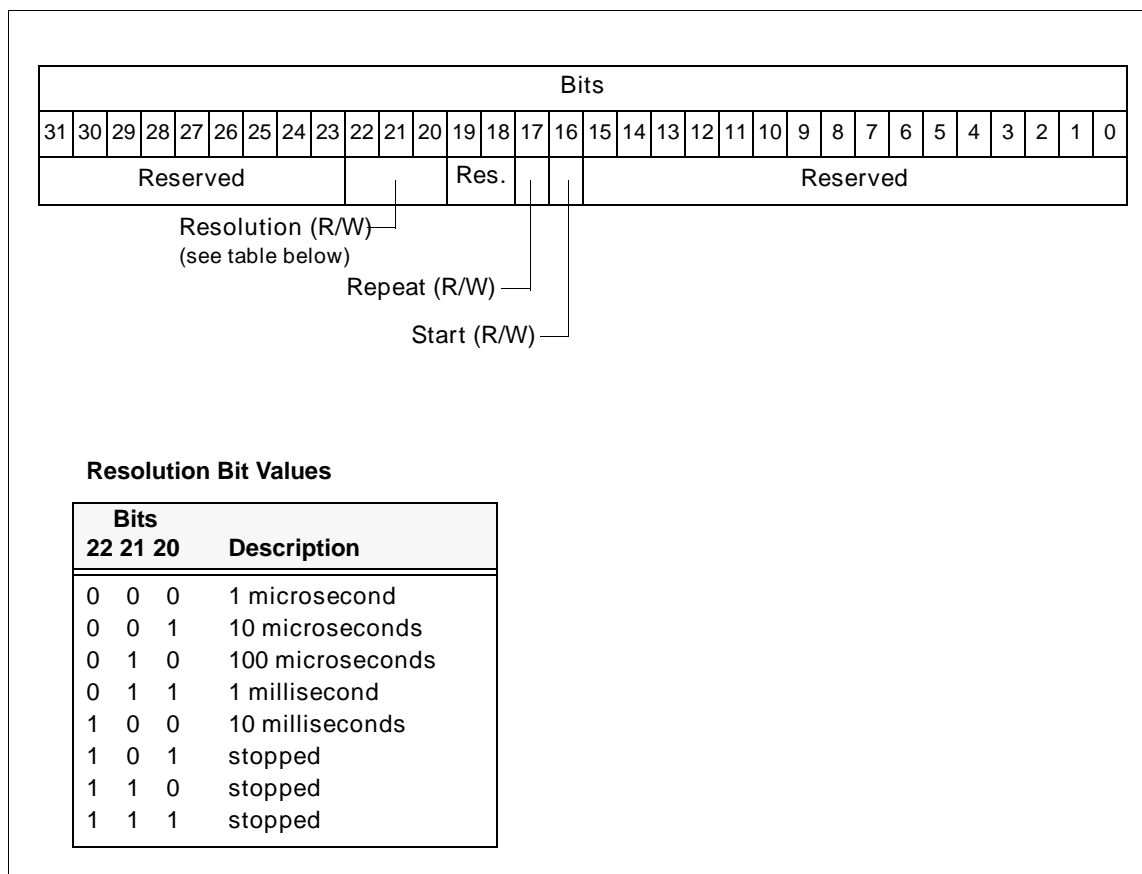

**Figure A-23 RCIM III Programmable Interrupt Generator Register (PIG)**

This register identifies the programmable interrupts.

Offset: 3000

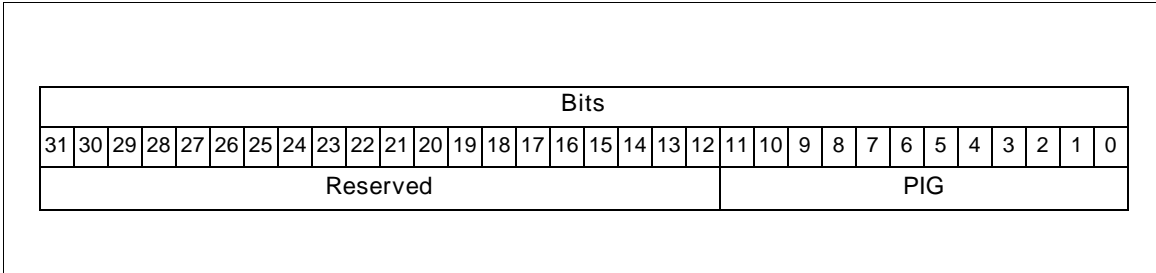

**Figure A-24 RCIM III Programmable Interrupt Set/Clear Registers (PIGS, PIGC)**

Writing to these registers sets/clears the unitary bits in the Programmable Interrupt Register without affecting the other bits.

Offsets: PIGS: 3010, PIGC: 3020

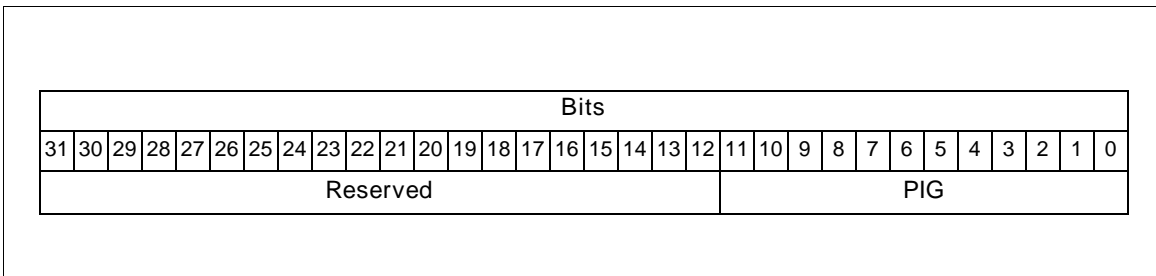
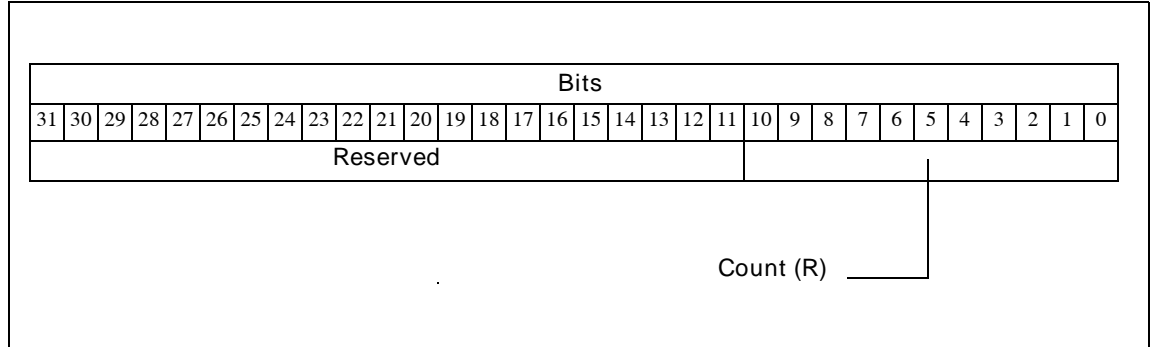



**Figure A-25 RCIM III SPI Count Register (SCR)**

The SPI (serial peripheral interface) count register contains the count for SPI transfers. The SPI interface is used to program the FPGA serial prom.

Offset: 3100



**Figure A-26 RCIM III GPS Receive Pointers (GRXP)**

The GPS receive pointers are used for communication with the optional GPS module.

Offset: 3200

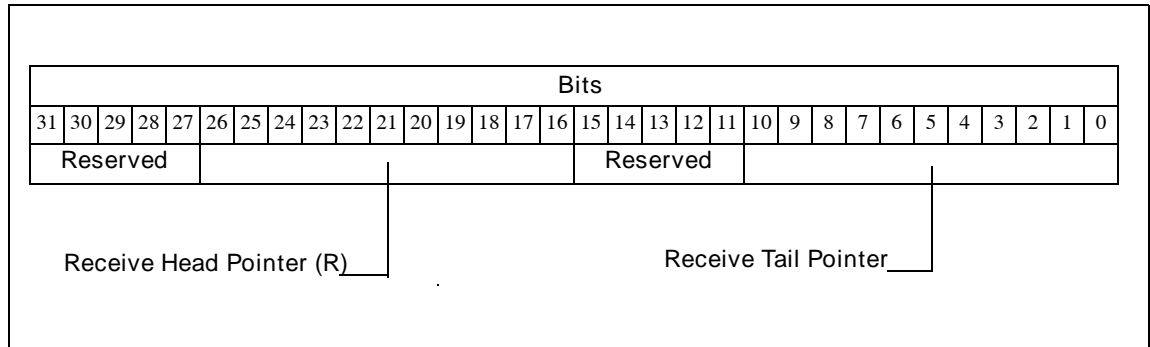

**Figure A-27 RCIM III GPS Transmit Pointers (GTXP)**

The GPS transmit pointers are used for communication with the optional GPS module.

Offset: 3204

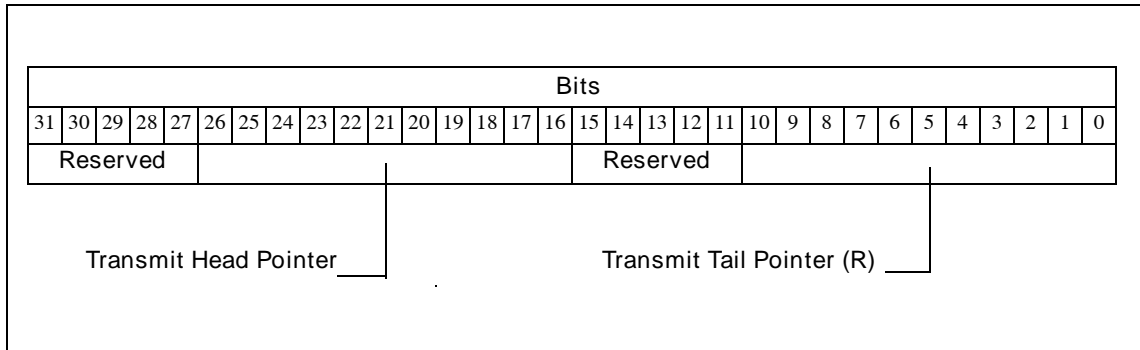

**Figure A-28 RCIM III GPS Debug Control Register (GDCR)**

The GPS debug control register contains bits used during testing and debug. Setting any of these bits will disable RCIM communication with the GPS module.

Offset: 3208

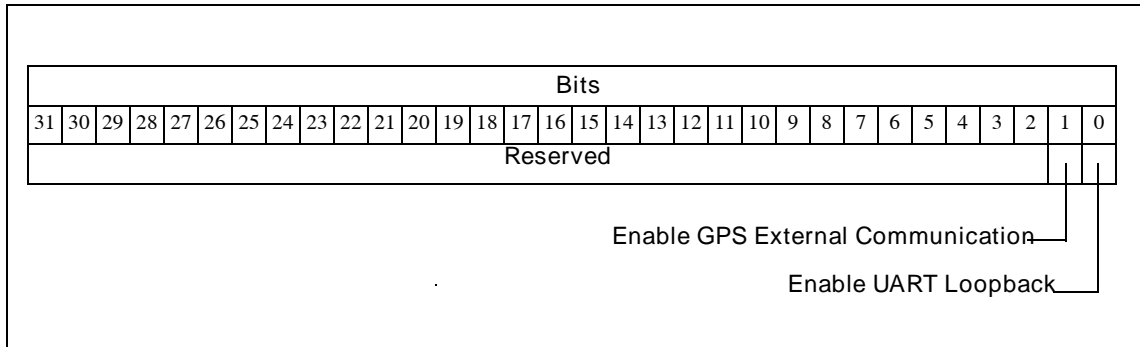
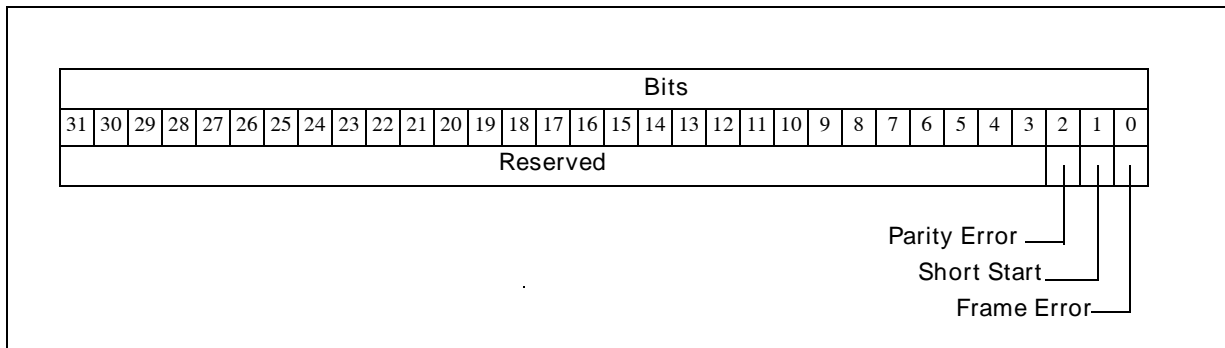

**Figure A-29 RCIM III GPS Communication Error Register (GCER)**

The GPS communication error register contains information regarding communication errors with the GPS module.

Any write to this register will reset the communication interface to the GPS module.

Offset: 320C



**Figure A-30 RCIM III SPI Data Buffer (SDB)**

This is the SPI Data buffer.

Offset: 3800 to 3FFF

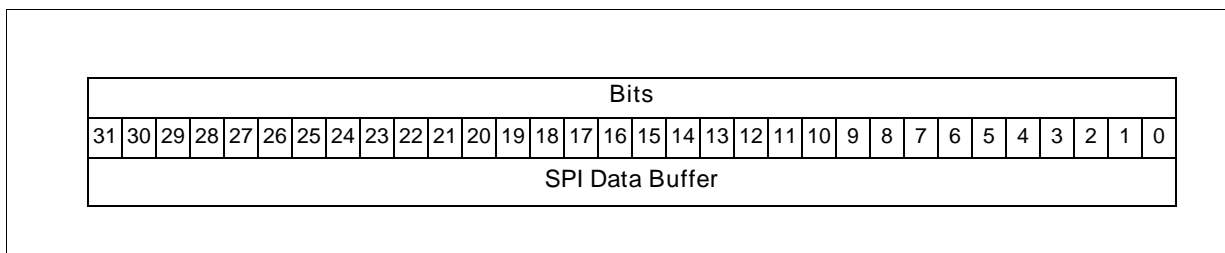

**Figure A-31 RCIM III GPS Receive Data Buffer (GRDB)**

This is the GPS receive data buffer.

Offset: 4000 to 47FF

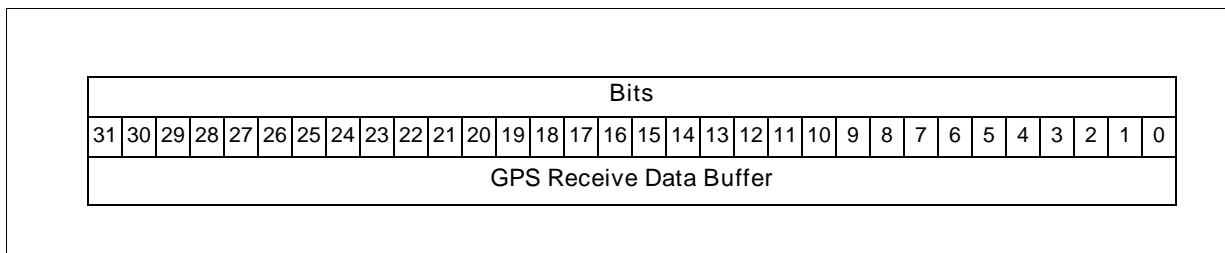

**Figure A-32 RCIM III GPS Transmit Data Buffer (GRDB)**

This is the GPS transmit data buffer.

Offset: 4800 to 4FFF

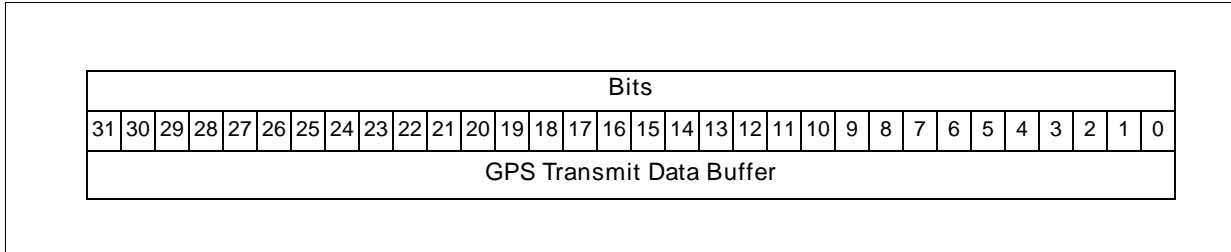

## RCIM II Registers

This section contains the address map and registers on the RCIM II board.

### RCIM II Address Map

Address	Function
0xXXXX0000	Board Status/Control Register (BSCR)
0xXXXX0004	FirmwareRev/OptionsPresentRegister (FWOP)
0xXXXX0010	Interrupt Enable Register #1 (IER1)
0xXXXX0014	Interrupt Enable Register #2 (IER2)
0xXXXX0020	Interrupt Request Register #1 (IRR1) (Write Only)
0xXXXX0024	Interrupt Request Register #2 (IRR2) (Write Only)
0xXXXX0020	Interrupt Pending Register #1 (IPR1) (Read Only)
0xXXXX0024	Interrupt Pending Register #2 (IPR2) (Read Only)
0xXXXX0030	Interrupt Clear Register #1 (ICR1)
0xXXXX0034	Interrupt Clear Register #2 (ICR2)
0xXXXX0040	Interrupt Arm Register #1 (IAR1)
0xXXXX0044	Interrupt Arm Register #2 (IAR2)
0xXXXX0050	Interrupt Select Level Register #1 (ISLR1)
0xXXXX0054	Interrupt Select Level Register #2 (ISLR2)
0xXXXX0060	Interrupt Select Polarity Register #1 (ISPR1)
0xXXXX0064	Interrupt Select Polarity Register #2 (ISPR2)
0xXXXX0070	External Interrupt Routing Register #1 (EIRR1)
0xXXXX0074	External Interrupt Routing Register #2 (EIRR2)
0xXXXX0078	External Interrupt Routing Register #3 (EIRR3)
0xXXXX0080	Cable Interrupt Routing Register #1 (CIRR1)
0xXXXX0084	Cable Interrupt Routing Register #2 (CIRR2)
0xXXXX0088	Cable Interrupt Routing Register #3 (CIRR3)
0xXXXX00A0	PCI Interrupt A Routing Register #1 (PARR1)
0xXXXX00A4	PCI Interrupt A Routing Register #2 (PARR2)
0xXXXX00B0	PCI Interrupt B Routing Register #1 (PBRR1)
0xXXXX00B4	PCI Interrupt B Routing Register #2 (PBRR2)
0xXXXX00C0	PCI Interrupt C Routing Register #1 (PCRR1)
0xXXXX00C4	PCI Interrupt C Routing Register #2 (PCRR2)
0xXXXX00D0	PCI Interrupt D Routing Register #1 (PDRR1)
0xXXXX00D4	PCI Interrupt D Routing Register #2 (PDRR2)
0xXXXX0100	DDS Adjust Register #1 (DDS)
0xXXXX0200	PPS Snapshot Register (PPS) (Read Only)
0xXXXX0300	GPS Transmit/Receive Register (GPS)
0xXXXX0400	Clear Cable Errors (CCERR) (Write Only)
0xXXXX1000	Tick Clock Upper (TCU)
0xXXXX1008	Tick Clock Lower (TCL)
0xXXXX1010	Tick Clock Status/Control (TCSC)

Address	Function		
0xXXXX1100	POSIX Clock Seconds	(PCS)	
0xXXXX1108	POSIX Clock Nanoseconds	(PCN)	
0xXXXX1110	POSIX Clock Status/Control	(PCSC)	
0xXXXX1114	POSIX Clock Skip/Add Time	(PCSAT)	(Write Only)
0xXXXX2000	RTC #0 Control	(RTC0C)	
0xXXXX2010	RTC #0 Timer	(RTC0T)	
0xXXXX2014	RTC #0 Repeat	(RTC0R)	
0xXXXX2020	RTC #1 Control	(RTC1C)	
0xXXXX2030	RTC #1 Timer	(RTC1T)	
0xXXXX2034	RTC #1 Repeat	(RTC1R)	
0xXXXX2040	RTC #2 Control	(RTC2C)	
0xXXXX2050	RTC #2 Timer	(RTC2T)	
0xXXXX2054	RTC #2 Repeat	(RTC2R)	
0xXXXX2060	RTC #3 Control	(RTC3C)	
0xXXXX2070	RTC #3 Timer	(RTC3T)	
0xXXXX2074	RTC #3 Repeat	(RTC3R)	
0xXXXX2080	RTC #4 Control	(RTC4C)	
0xXXXX2090	RTC #4 Timer	(RTC4T)	
0xXXXX2094	RTC #4 Repeat	(RTC4R)	
0xXXXX20A0	RTC #5 Control	(RTC5C)	
0xXXXX20B0	RTC #5 Timer	(RTC5T)	
0xXXXX20B4	RTC #5 Repeat	(RTC5R)	
0xXXXX20C0	RTC #6 Control	(RTC6C)	
0xXXXX20D0	RTC #6 Timer	(RTC6T)	
0xXXXX20D4	RTC #6 Repeat	(RTC6R)	
0xXXXX20E0	RTC #7 Control	(RTC7C)	
0xXXXX20F0	RTC #7 Timer	(RTC7T)	
0xXXXX20F4	RTC #7 Repeat	(RTC7R)	
0xXXXX3000	Programmable Interrupt Generator	(PIG)	
0xXXXX3010	Programmable Interrupt Generator Set	(PIGS)	(Write Only)
0xXXXX3020	ProgrammableInterruptGeneratorClear	(PIGC)	(Write Only)

## RCIM II Registers

RCIM II registers are illustrated in this section.

**NOTE:** Unless otherwise stated, a bit value of 1=on; 0=off.

**Figure A-33 RCIM II Board Status/Control Register (BSCR)**

This register provides status and control of certain features of the RCIM II board.

Offset: 0000

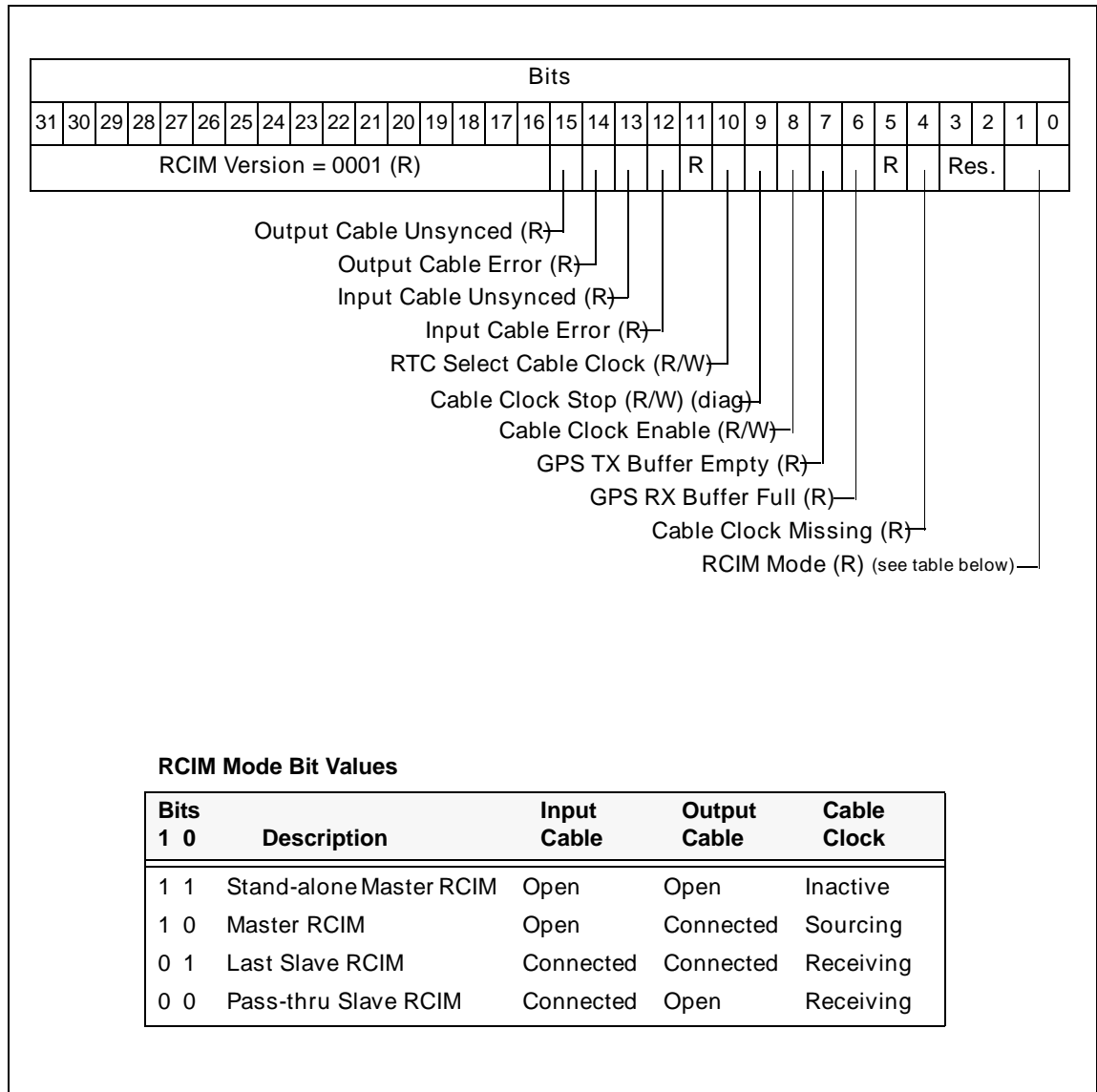

**Figure A-34 RCIM II Firmware Revision/Options Present Register (FWOP)**

This register provides information on what options are present on this RCIM board and the firmware revision.

Offset: 00004

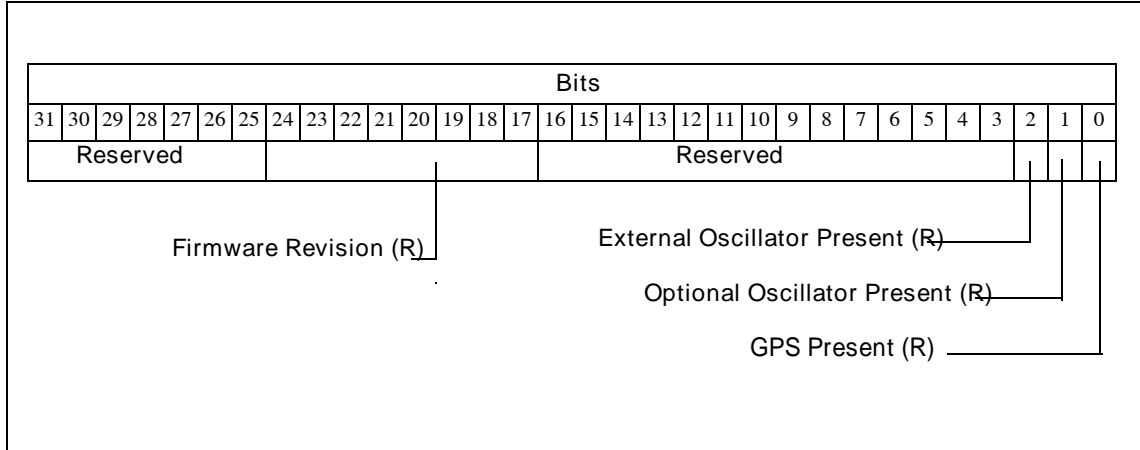
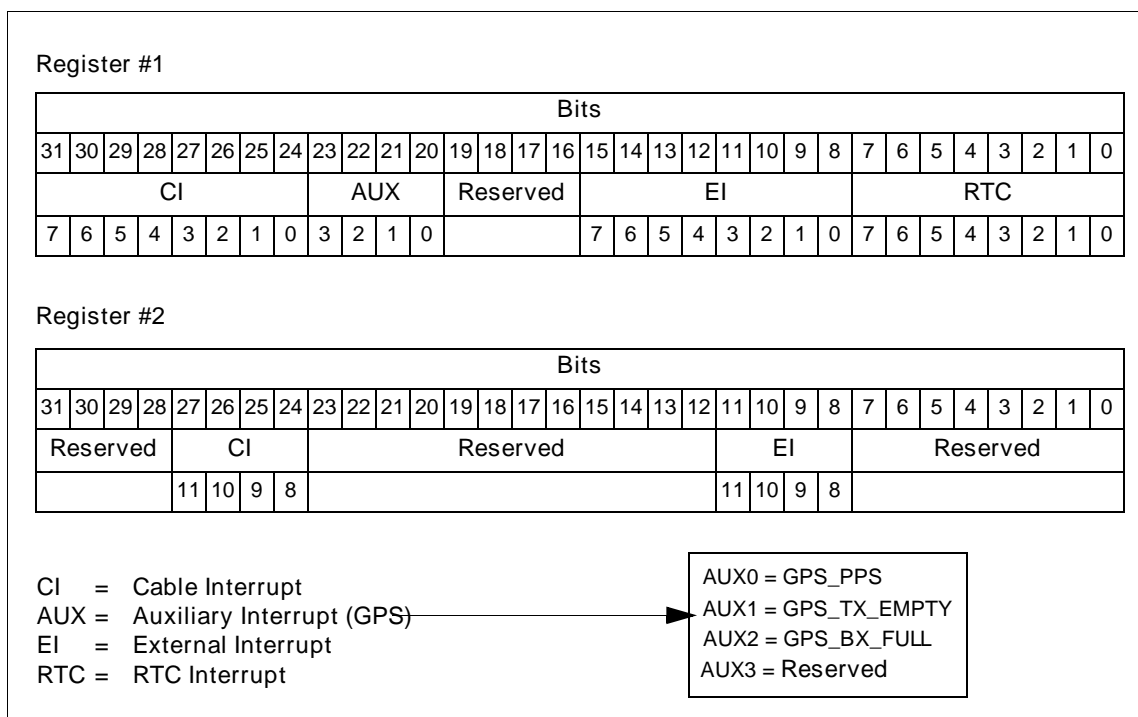



**Figure A-35 RCIM II Interrupt Enable/Request/Pending/Clear/Arm/Level/Polarity Registers (IER, IRR, IPR, ICR, IAR, ISLR, ISPR)**

The enable registers (IER) enable the selected interrupts.  
 The request registers (IRR) are software driven requests of the selected interrupts.  
 The pending registers (IPR) are pending requests.  
 The clear registers (ICR) clear the selected interrupts.  
 The arm registers (IAR) arm the selected interrupts for edge triggering.  
 The level registers (ISLR) set level (1) or edge (0) for the selected interrupts.  
 The polarity registers (ISPR) set polarity high (1) or low (0) for the selected interrupts.

Offsets: IER1: 0010, IER2: 0014, IRR1/IPR1: 0020, IRR2/IPR2: 0024, ICR1: 0030, ICR2: 0034,  
 IAR1: 0040, IAR2: 0044, ISLR1: 0050, ISLR2: 0054, ISPR1: 0060, ISPR2: 0064



**Figure A-36 RCIM II External Interrupt Routing Registers (EIRR)**

The external interrupt routing registers route selected interrupts to the external interrupt connector.

Offset: EIRR1: 0070, EIRR2: 0074, EIRR3: 0078

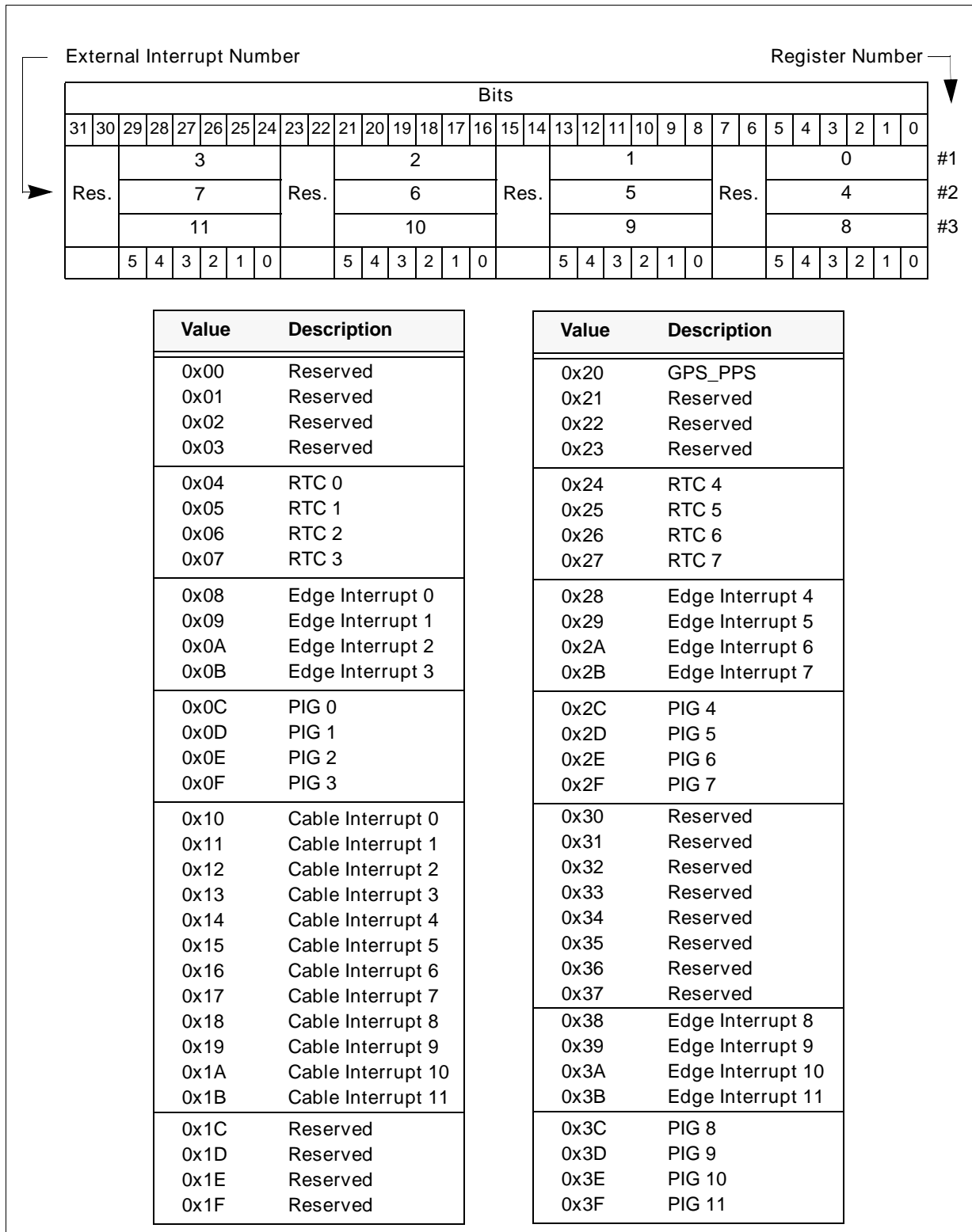

**Figure A-37 RCIM II Cable Interrupt Routing Registers (CIRR)**

The cable interrupt routing registers route selected interrupts to the RCIM interconnecting cable.

Offsets: CIRR1: 0080, CIRR2: 0084, CIRR3: 0088

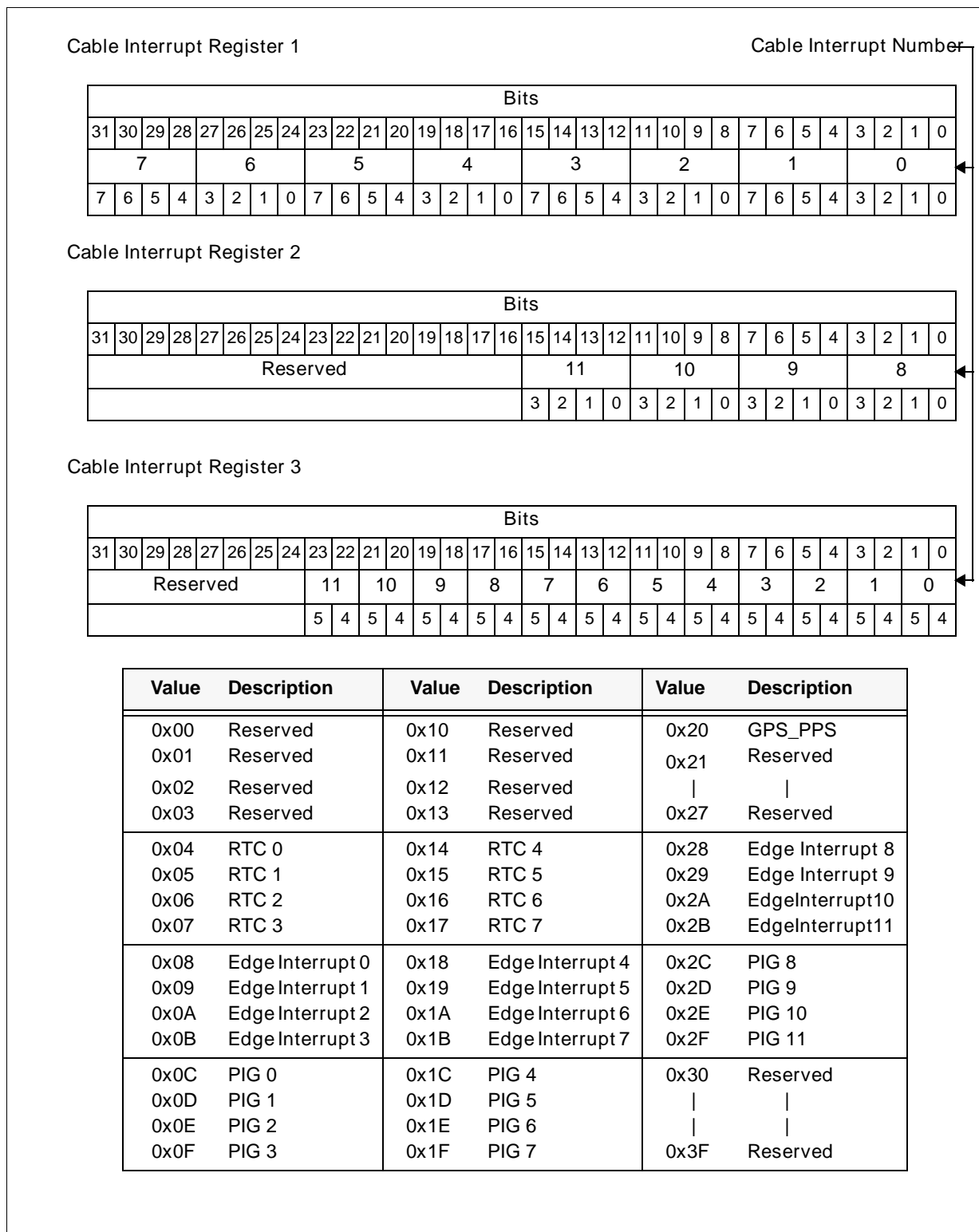

**Figure A-38 RCIM II PCI Interrupt Routing Registers (PARR, PBRR, PCRR, PDRR)**

Setting a bit in a PCI interrupt routing register routes selected interrupts to the designated PCI interrupt. The default power-up value is everything routed to PCI A. Setting bits in multiple registers will drive multiple PCI interrupt lines.

Offsets: PARR1: 00A0, PARR2: 00A4, PBRR1: 00B0, PBRR2: B4, PCRR1: 00C0, PCRR2: 00C4, PDRR1: 00D0, PDRR2 00D4

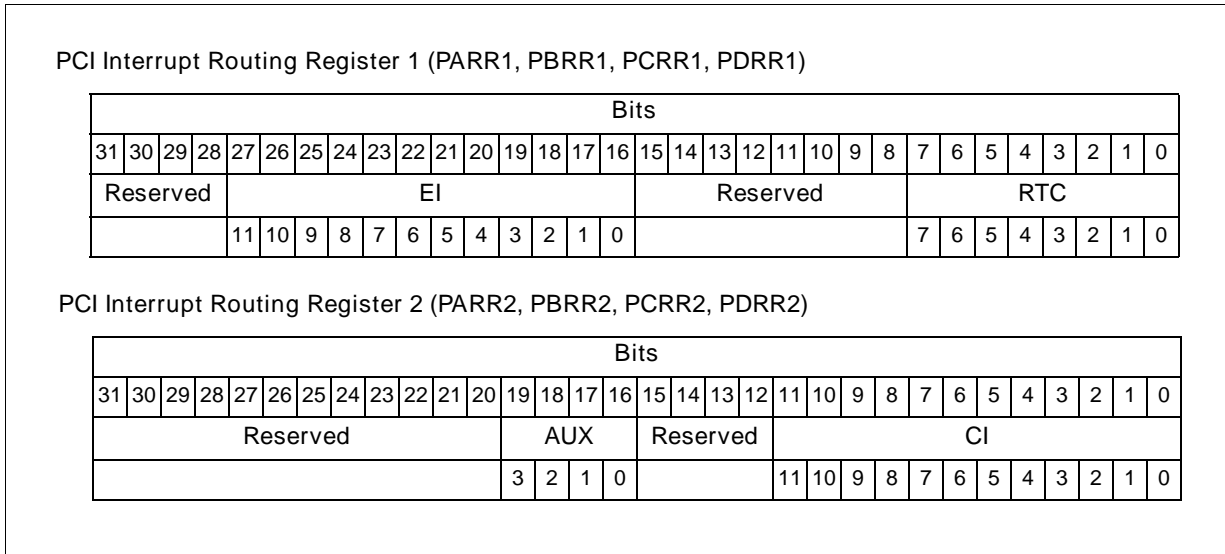

**Figure A-39 RCIM II DDS Adjust Register (DDS)**

Writing to the Direct Digital Synthesizer Adjust register loads the 32-bit frequency control word into the onboard AD9851 DDS.

Offset: 0100

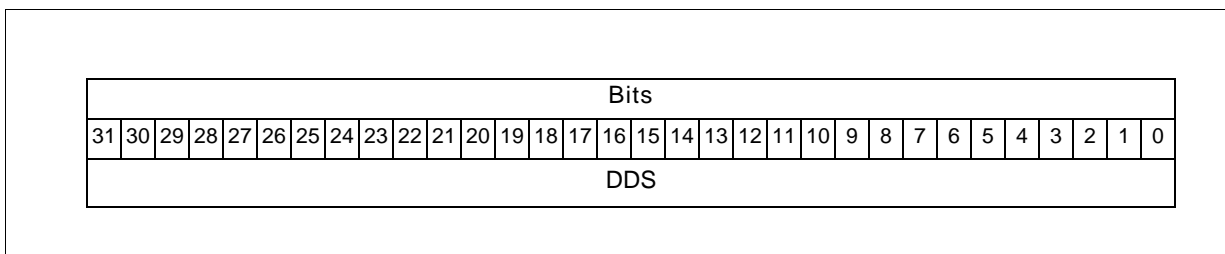

**Figure A-40 RCIM II PPS Snapshot Register (PPS)**

The PPS Snapshot register contains a snapshot of the nanoseconds field and two bits of the seconds field of the POSIX clock. The snapshot is taken every time the GPS PPS signal occurs.

Offset: 0200

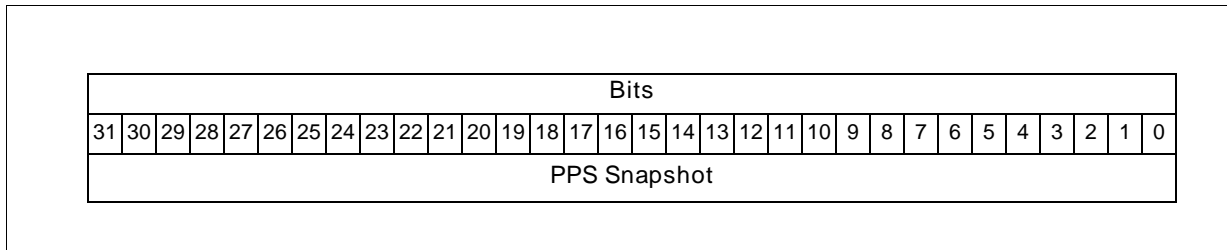
**Figure A-41 RCIM II GPS Transmit/Receive Register (GPS)**

The GPS Transmit/Receive register is used for serial communication with the GPS module via the PCI bus interface.

Offset: 0300

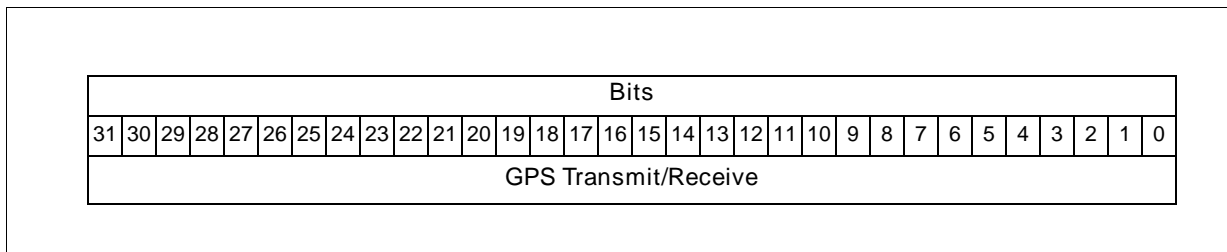
**Figure A-42 RCIM II Clear Cable Errors Register (CCERR)**

This is a Write Only register that clears any reported cable errors. The data field is don't care.

Offset: 0400

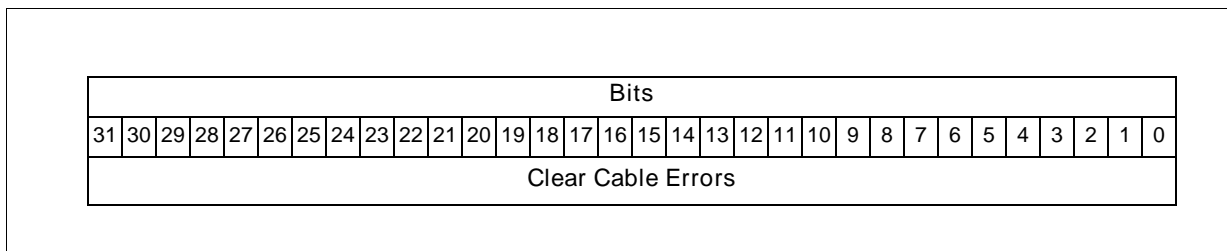

**Figure A-43 RCIM II Tick Clock Upper Register (TCU)**

This register contains the upper 32 bits of the tick clock.

Offset: 1000

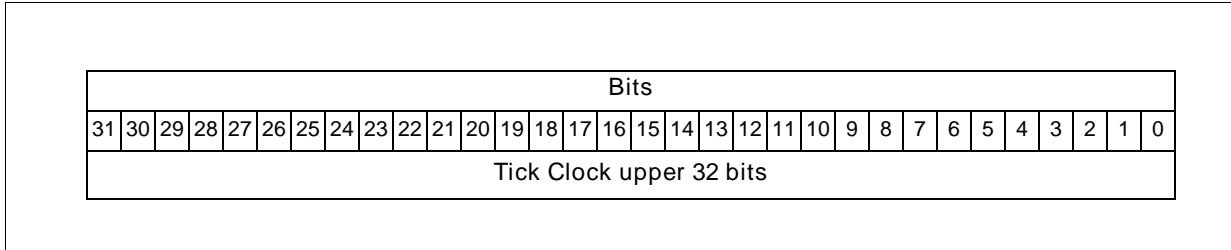

**Figure A-44 RCIM II Tick Clock Lower Register (TCL)**

This register contains the lower 32 bits of the tick clock.

Offset: 1008

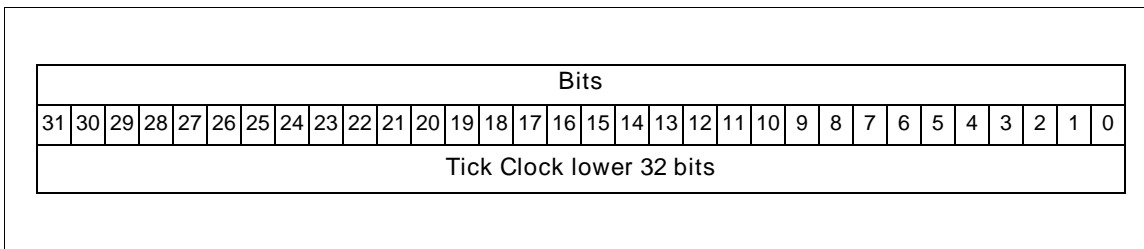

**Figure A-45 RCIM II Tick Clock Status/Control Register (TCSC)**

This register provides status and control of the tick clock.

Offset: 1010

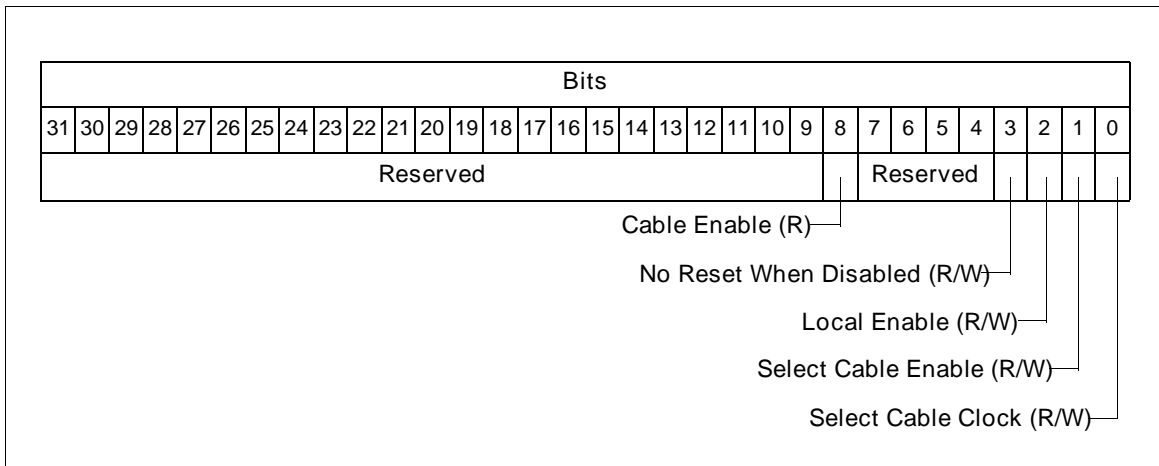

**Figure A-46 RCIM II POSIX Clock Seconds Register (PCS)**

This register contains the POSIX clock seconds.

Offset: 1100

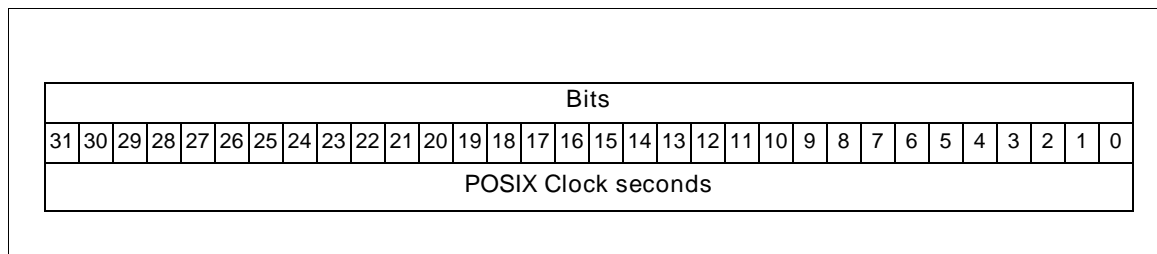
**Figure A-47 RCIM II POSIX Clock Nanoseconds Register (PCN)**

This register contains the POSIX clock nanoseconds.

Offset: 1108

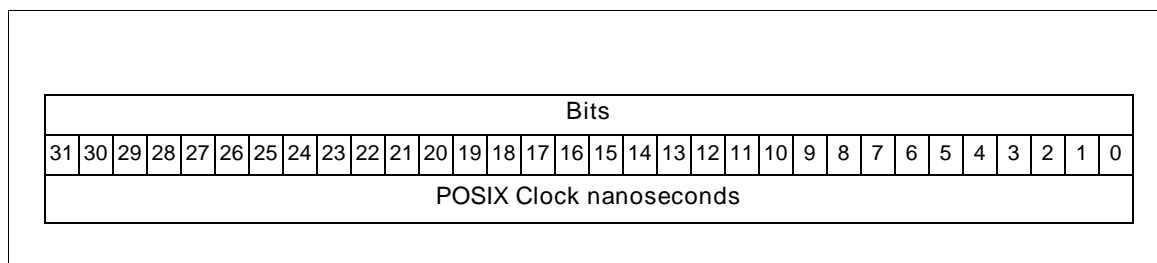

**Figure A-48 RCIM II POSIX Clock Status/Control Register (PCSC)**

This register provides status and control of the POSIX clock.

Offset: 1110

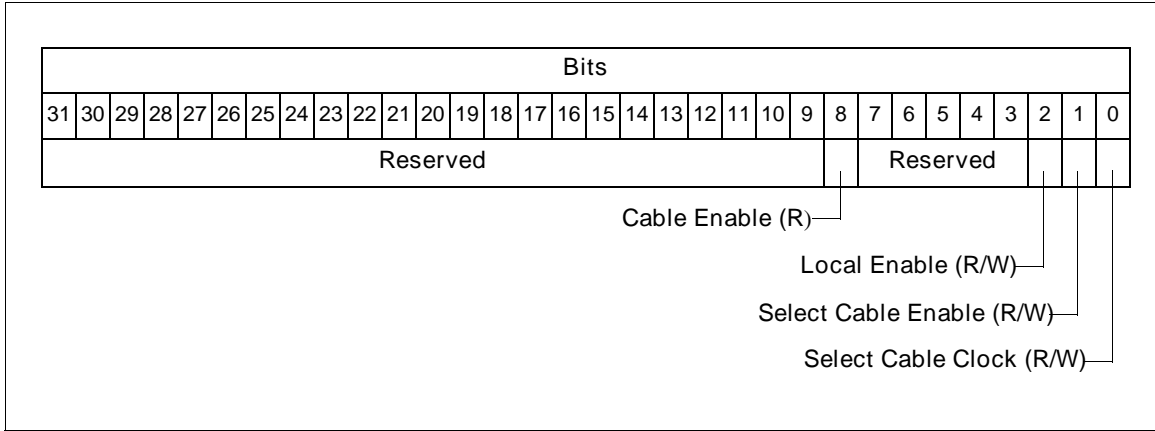

**Figure A-49 RCIM II POSIX Clock Skip/Add Time Register (PCSAT)**

This register skips/adds time to the POSIX clock in 400 nanosecond increments.

Offset: 1114

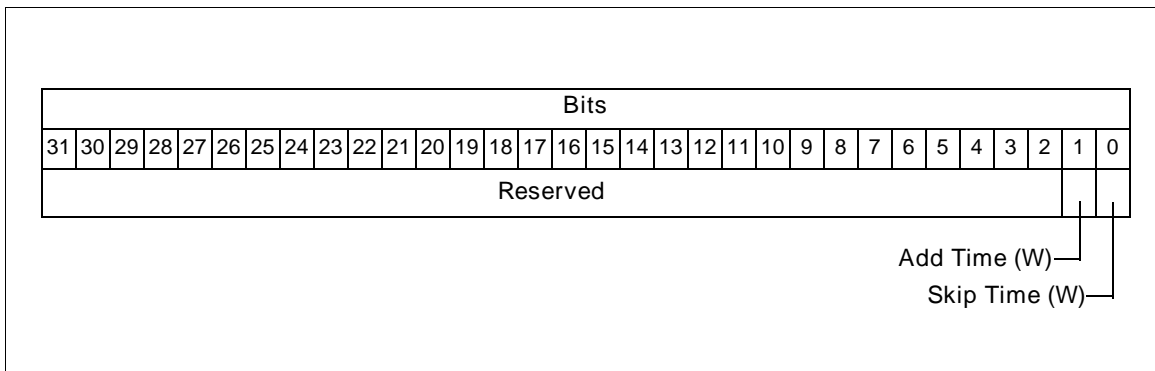
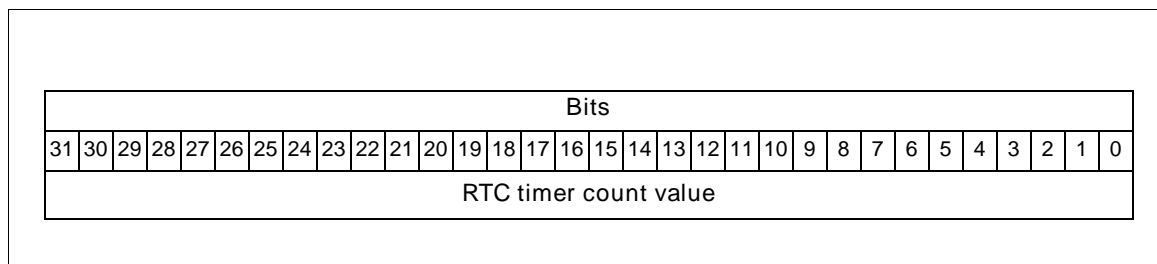



**Figure A-50 RCIM II RTC Timer Registers (RTCT)**

The initial RTC timer value is loaded in the RTC timer registers. The current value of the timer is read from this register. NOTE: Loading this register also loads the RTC Repeat Register for compatibility with RCIM.

Offsets: RTC0T: 2010, RTC1T: 2030, RTC2T: 2050, RTC3T: 2070, RTC4T: 2090, RTC5T: 20B0,  
RTC6T: 20D0, RTC7T: 20F0

**Figure A-51 RCIM II RTC Repeat Registers (RTCR)**

The RTC repeat registers contain the repeat count value.

Offsets: RTC0R: 2014, RTC1R: 2034, RTC2R: 2054, RTC3R: 2074, RTC4R: 2094, RTC5R: 20B4,  
RTC6R: 20D4, RTC7R: 20F4

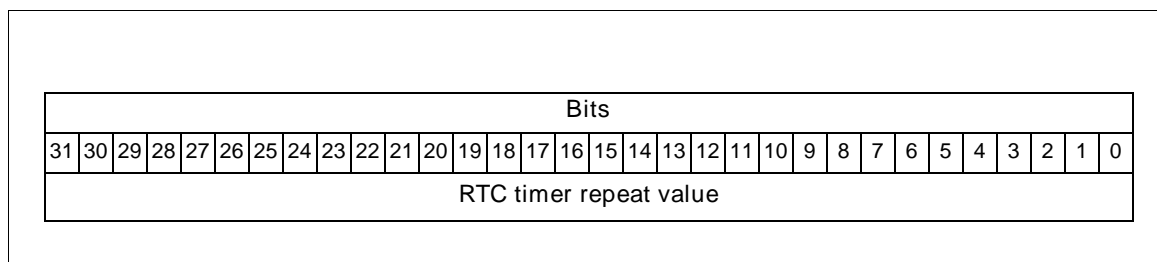

**Figure A-52 RCIM II RTC Control Registers (RTCC)**

This register provides control of the RTCs.

Offsets: RTC0C: 2000, RTC1C: 2020, RTC2C: 2040, RTC3C: 2060, RTC4C: 2080, RTC5C: 20A0,  
 RTC6C: 20C0, RTC7C: 20E0

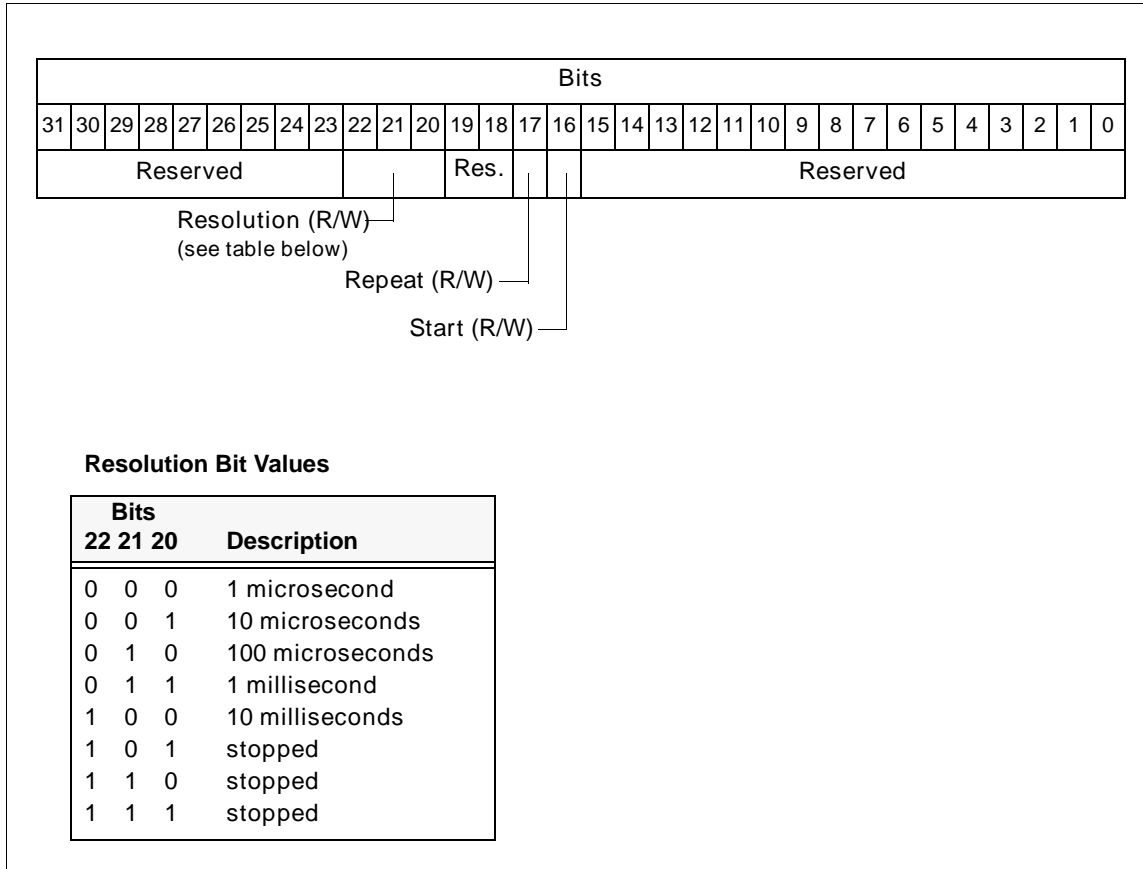

**Figure A-53 RCIM II Programmable Interrupt Generator Register (PIG)**

This register identifies the programmable interrupts.

Offset: 3000

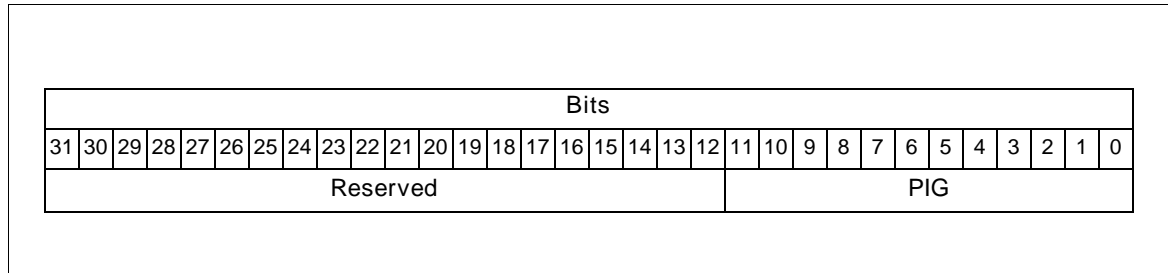
**Figure A-54 RCIM II Programmable Interrupt Set/Clear Registers (PIGS, PIGC)**

Writing to these registers sets/clears the unitary bits in the Programmable Interrupt Register without affecting the other bits.

Offsets: PIGS: 3010, PIGC: 3020

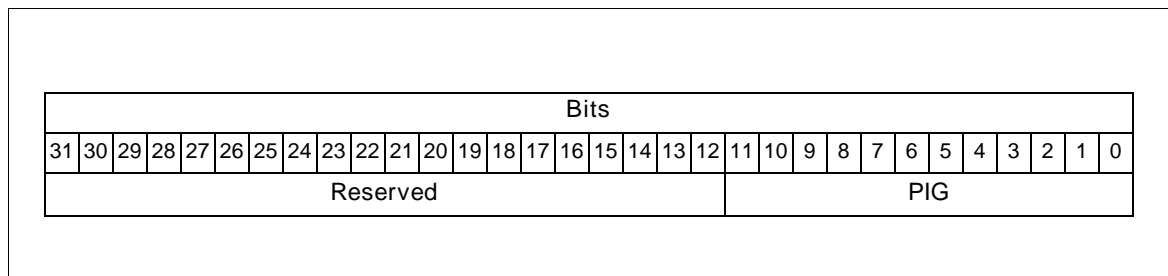

## RCIM I Registers

This section contains the address map and registers on the RCIM I board.

### RCIM I Address Map

Address	Function
0xXXXX0000	Board Status/Control Register (BSCR)
0xXXXX0010	Interrupt Enable Register (IER)
0xXXXX0020	Interrupt Request Register (IRR) (Write Only)
0xXXXX0020	Interrupt Pending Register (IPR) (Read Only)
0xXXXX0030	Interrupt Clear Register (ICR)
0xXXXX0040	Interrupt Arm Register (IAR)
0xXXXX0050	Interrupt Select Level Register (ISLR)
0xXXXX0060	Interrupt Select Polarity Register (ISPR)
0xXXXX0070	ExternalInterruptRoutingRegister (EIRR)
0xXXXX0080	Cable Interrupt Routing Register (CIRR)
0xXXXX1000	Tick Clock Upper (TCU)
0xXXXX1008	Tick Clock Lower (TCL)
0xXXXX1010	Tick Clock Status/Control (TCSC)
0xXXXX1100	POSIX Clock Seconds (PCS)
0xXXXX1108	POSIX Clock Nanoseconds (PCN)
0xXXXX1110	POSIX Clock Status/Control (PCSC)
0xXXXX2000	RTC #0 Control
0xXXXX2010	RTC #0 Timer
0xXXXX2020	RTC #1 Control
0xXXXX2030	RTC #1 Timer
0xXXXX2040	RTC #2 Control
0xXXXX2050	RTC #2 Timer
0xXXXX2060	RTC #3 Control
0xXXXX2070	RTC #3 Timer
0xXXXX3000	ProgrammableInterruptGenerator (PIG)

## RCIM I Registers

RCIM I registers are illustrated in this section.

**NOTE:** Unless otherwise stated, a bit value of 1=on; 0=off.

**Figure A-55 RCIM I Board Status/Control Register (BSCR)**

This register provides status and control of certain features of the RCIM I board.

Offset: 0000

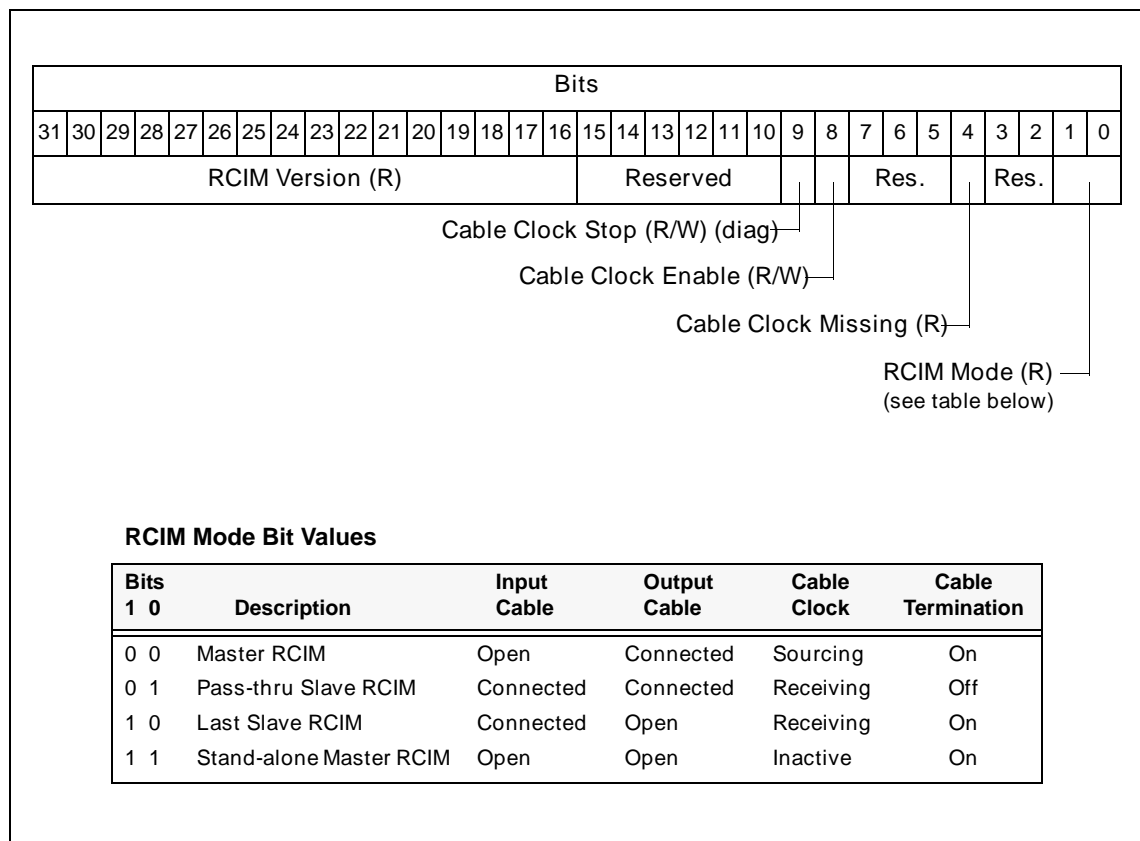

**Figure A-56 RCIM I Interrupt Enable/Request/Pending/Clear/ARM/Level/Polarity Registers (IER, IRR, IPR, ICR, IAR, ISLR, ISPR)**

The enable register (IER) enables the selected interrupt.  
 The request register (IRR) is a software driven request of the selected interrupt.  
 The pending register (IPR) is a pending request.  
 The clear register (ICR) clears the selected interrupt.  
 The arm register (IAR) arms the selected interrupt for edge triggering.  
 The level register (ISLR) sets level (1) or edge (0) for the selected interrupt.  
 The polarity register (ISPR) sets polarity high (1) or low (0) for the selected interrupt.

Offsets: IER: 0010, IRR/IPR: 0020, ICR: 0030, IAR: 0040, ISLR: 0050, ISPR: 0060

Bits																															
31	30	29	28	27	26	25	24	23	22	21	20	19	18	17	16	15	14	13	12	11	10	9	8	7	6	5	4	3	2	1	0
CI								Reserved				PIG				Reserved				EI				Reserved				RTC			
7	6	5	4	3	2	1	0					3	2	1	0					3	2	1	0					3	2	1	0

CI = Cable Interrupt  
 PIG = Programmable Interrupt Generator  
 EI = External Interrupt  
 RTC = RTC Interrupt

**Figure A-57 RCIM I External Interrupt Routing Register (EIRR)**

The external interrupt routing register routes selected interrupts to the external interrupt connector.

Offset: 0070

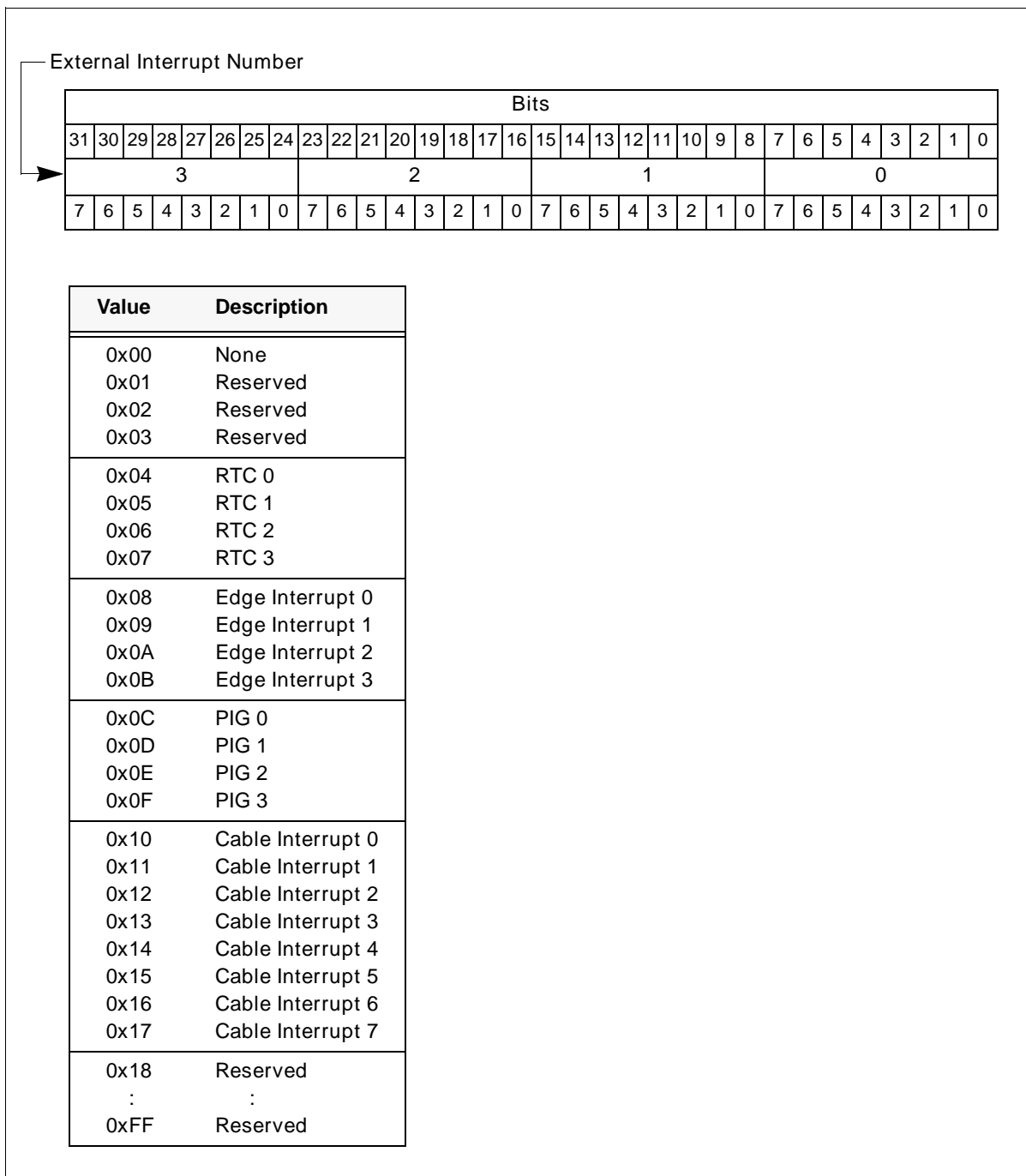

**Figure A-58 RCIM I Cable Interrupt Routing Register (CIRR)**

The cable interrupt routing register routes selected interrupts to the RCIM I interconnecting cable.

Offset: 0080

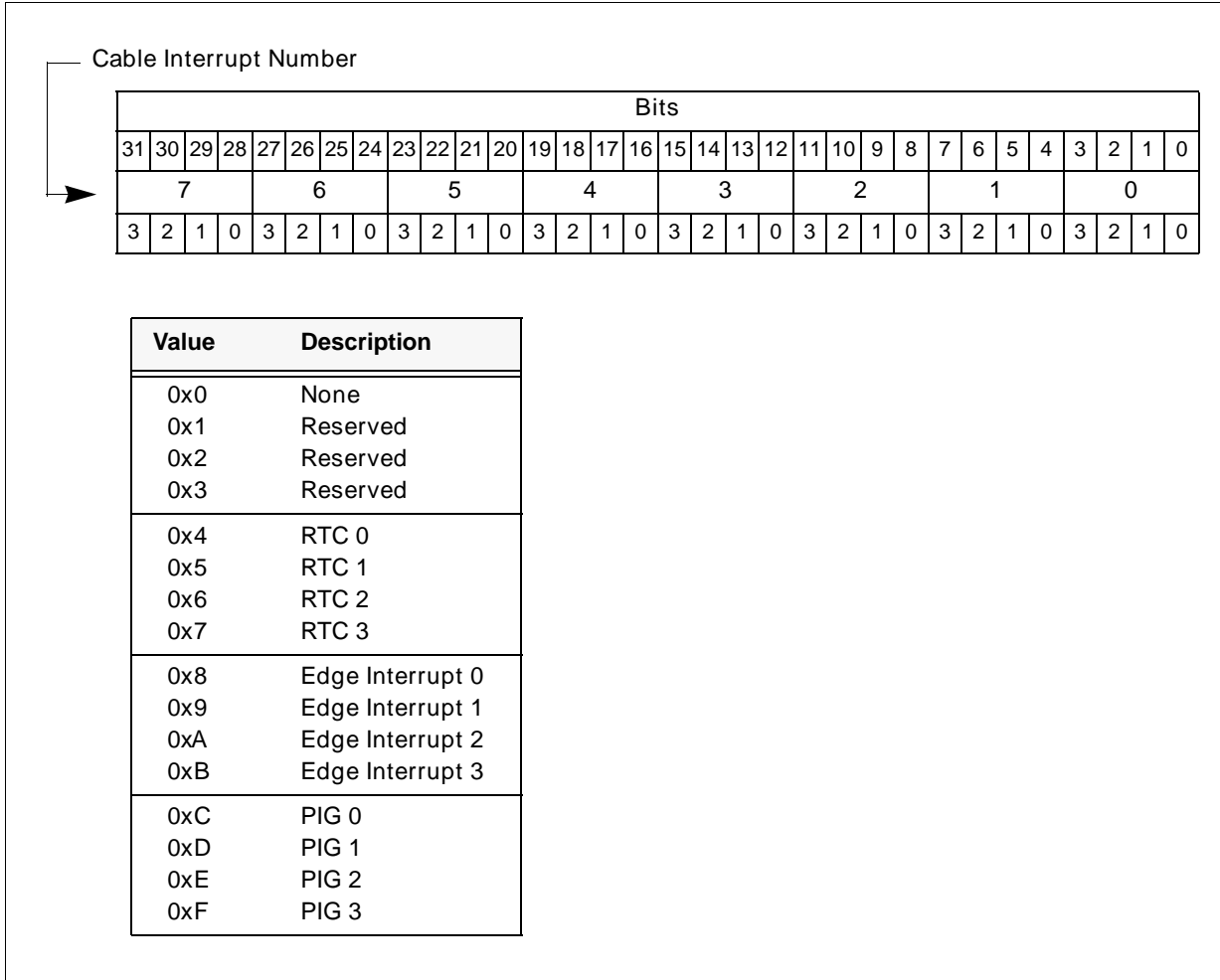
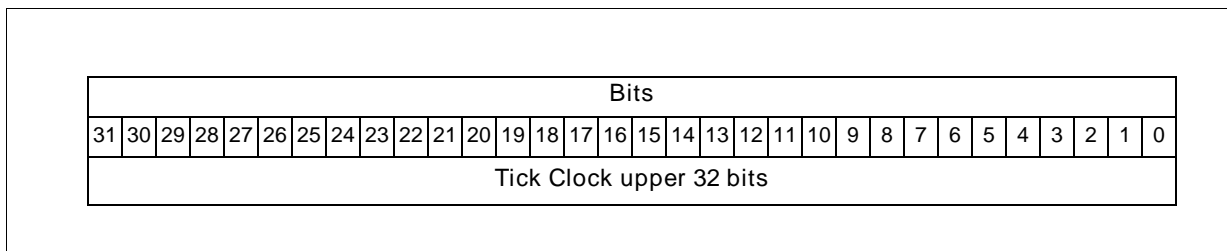



**Figure A-59 RCIM I Tick Clock Upper Register (TCU)**

This register contains the upper 32 bits of the tick clock.

Offset: 1000



**Figure A-60 RCIM I Tick Clock Lower Register (TCL)**

This register contains the lower 32 bits of the tick clock.

Offset: 1004

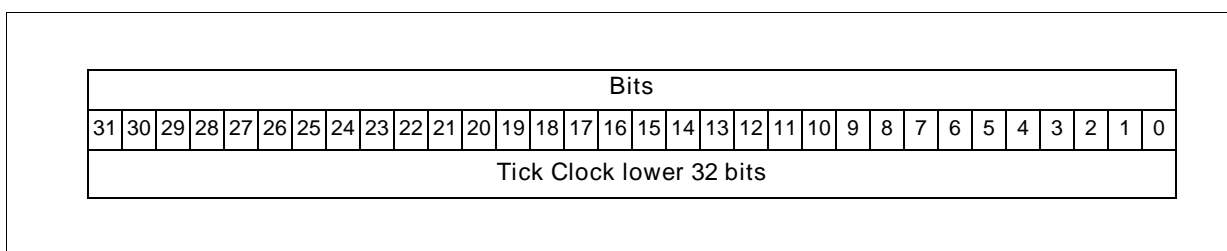

**Figure A-61 RCIM I Tick Clock Status/Control Register (TCSC)**

This register provides status and control of the tick clock.

Offset: 1010

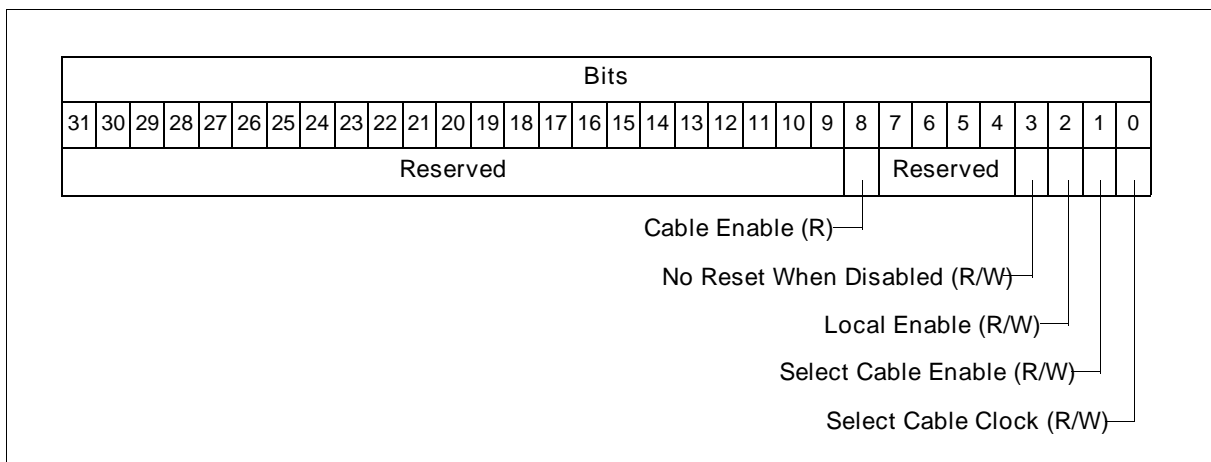

**Figure A-62 RCIM I POSIX Clock Seconds Register (PCS)**

This register contains the POSIX clock seconds.

Offset: 1100

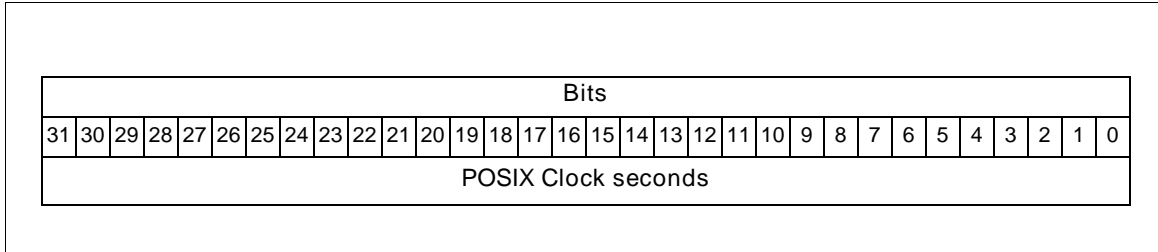

**Figure A-63 RCIM I POSIX Clock Nanoseconds Register (PCN)**

This register contains the POSIX clock nanoseconds.

Offset: 1104

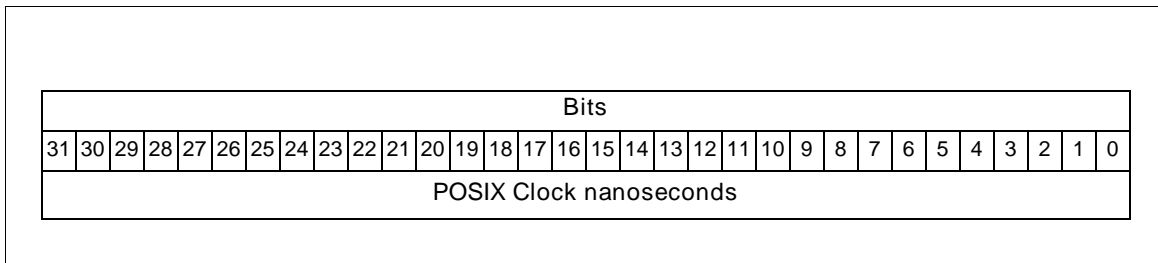

**Figure A-64 RCIM I POSIX Clock Status/Control Register (PCSC)**

This register provides status and control of the POSIX clock.

Offset: 1110

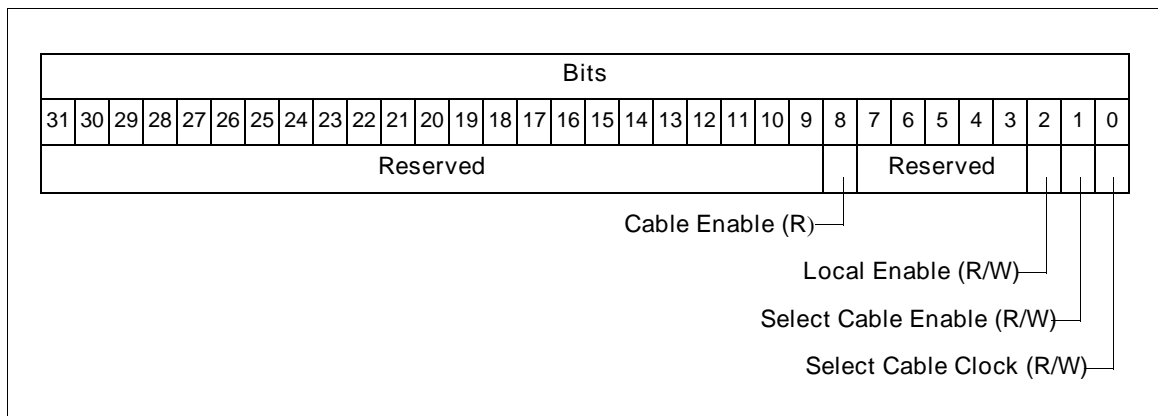

**Figure A-65 RCIM I RTC Control Registers**

This register provides control of the RTCs.

Offsets: RTC #0: 2000, RTC #1: 2020, RTC #2: 2040, RTC #3: 2060

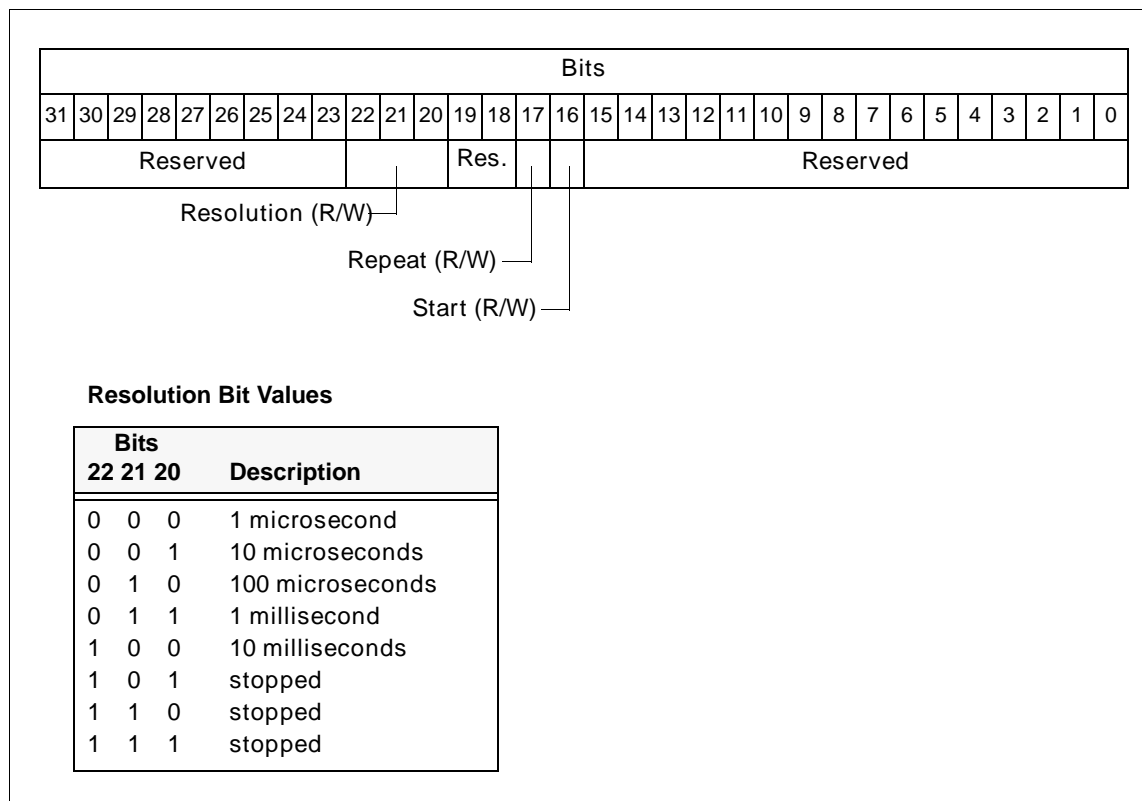

**Figure A-66 RCIM I RTC Timer Registers**

The initial RTC timer value is loaded in the RTC timer registers. The current value of the timer is read from this register.

Offsets: RTC #0: 2010, RTC #1: 2030, RTC #2: 2050, RTC #3: 2070

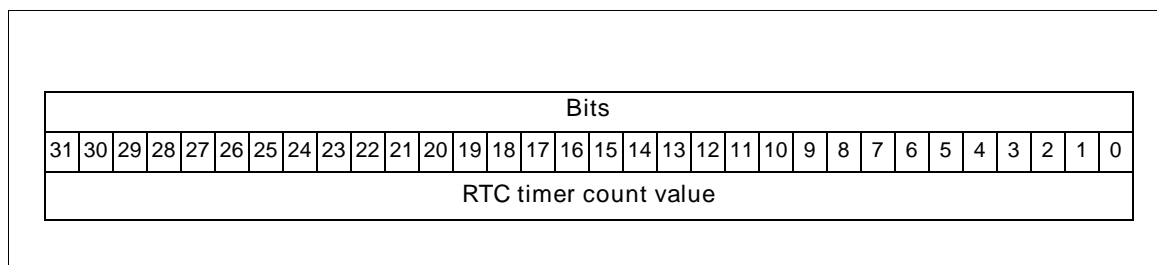

**Figure A-67 RCIM I Programmable Interrupt Generator Register (PIG)**

The PIG register identifies the programmable interrupts.

Offset: 3000

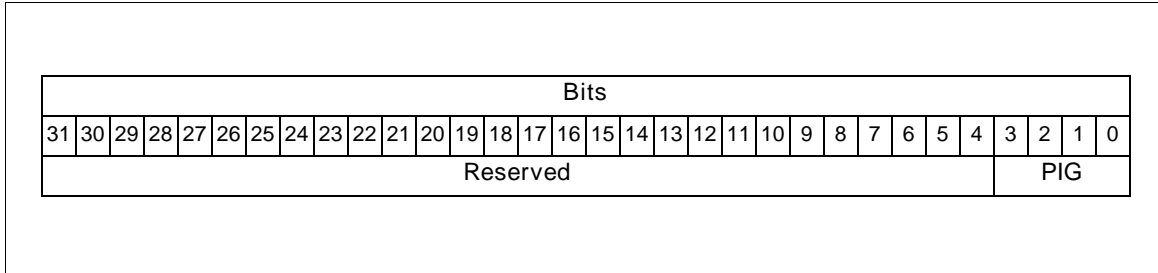

## Calculating RCIM Cable Propagation Delays

This appendix provides calculations to determine if your cable connections introduce signal delays.

### RCIM III

The maximum cable length between each interconnected RCIM III board is 30 meters (~100 feet).

The clock runs at 400ns per tick. If the clock signal takes more than 400ns to make it to any given slave in the chain, clock skew will occur from that point on. The clock is re-driven by each pass-through slave.

Due to synchronization and re-drive of the serial data on the cable, each RCIM III added to an RCIM chain adds about 50ns of delay in addition to approximately ~7ns for each meter of the cable, or ~200ns per 30 meter cable.

Two systems in an RCIM chain with the 30 meter cable will operate within a 400ns clock tick. Having more than two results in less precise synchronization.

Note that if a pass-through slave system is powered off, the cable clock will not be propagated to the slaves downstream from it. In this case, the downstream slaves will use their local oscillator instead of the cable clock.

The user just needs to be aware of the delays associated with each RCIM and cable in a chain to determine if the level of clock skew is acceptable for the application.

### RCIM II

The maximum cable length between each interconnected RCIM II board is 30 feet.

The clock runs at 400ns per tick. If the clock signal takes more than 400ns to make it to any given slave in the chain, clock skew will occur from that point on. The clock is re-driven by each pass-through slave.

Due to synchronization and re-drive of the serial data on the cable, each RCIM II added to an RCIM chain adds about 150ns of delay in addition to approximately 2ns for each foot of the cable, or 60ns per 30 foot cable.

Three systems in an RCIM chain will operate within the desired 400ns. Having more than three results in less precise synchronization.

Note that if a pass-through slave system is powered off, the cable clock will not be propagated to the slaves downstream from it. In this case, the downstream slaves will use their local oscillator instead of the cable clock.

If chaining is to be done through different locations using different grounds, talk to your Concurrent representative about the risk of ground loops.

## RCIM I

Synchronization cable lengths are constrained by the worst case propagation delay of the cable clock signal from the master RCIM to the final slave. The clock runs at 400ns per tick. If the clock signal takes more than 400ns to make it to any given slave in the chain, clock skew will occur from that point on. The clock is redriven by each pass-through slave. If you consider receive + transmit as taking equal time, it takes about 8.5ns for each half of the operation, or 17ns per RCIM to redrive the signal.

The propagation delay of the signal traveling through the cable is 2ns per foot. It would take 20ns to travel ten feet:

$$2\text{ns/ft} * 10\text{ft} = 20\text{ns}$$

Cable lengths should be minimized when possible. They do not need to have equal length.

The equation below describes how to calculate cable length limitations:

$$\text{total\_propagation\_delay(cables)} + \text{total\_propagation\_delay(rcims)} \leq 400\text{ns}$$

where:

$$\text{total\_propagation\_delay(rcims)} = (\text{number of RCIMs in the chain} - 1) * 17\text{ns}$$

$$\text{total\_propagation\_delay(cables)} = (\text{total length in feet of all cables in the chain}) * 2\text{ns}$$

The following example illustrates the calculations for an RCIM chain with 6 systems:

$$\begin{aligned} \text{total\_propagation\_delay(rcims)} &= (\text{number of RCIMs in the chain} - 1) * 17\text{ns} \\ &= (6-1) * 17\text{ns} \\ &= 5 * 17\text{ns} \\ &= 85\text{ns} \end{aligned}$$

$$\begin{aligned} \text{total\_propagation\_delay(cables)} &\leq 400\text{ns} - \text{total\_propagation\_delay(rcims)} \\ &\leq 400\text{ns} - 85\text{ns} \\ &\leq 315\text{ns} \end{aligned}$$

$$\begin{aligned} \text{In } 315\text{ns, the signal has traveled } &315\text{ns}/2\text{ns/ft} = 315/2 \text{ feet} \\ &= 157.5 \text{ feet} \end{aligned}$$

Conclusion: For six systems, the total length of cable can not exceed 157.5 feet.

These calculations are theoretical and may vary with the environment. They are intended as a "rule of thumb". The closer the total propagation delay is to 400ns, the greater the risk of introducing clock skew.

It is recommended that systems be placed as close together as practical in order to minimize propagation delays. Extremely long runs through high RF noise or high temperature environments should be avoided when planning RCIM cable routes.

Note that if a pass-through slave system is powered off, the cable clock will not be propagated to the slaves downstream from it. In this case, the downstream slaves will use their local oscillator instead of the cable clock.





## Paths

/dev/rcim\_uart 3-7  
/etc/init.d/rcim 2-20  
/etc/init.d/rcim\_clocksync 3-6  
/etc/sysconfig/rcim\_clocksync 3-6  
/proc/driver/rcim0 3-11  
/usr/include/linux/rcim\_ctl.h 3-11  
/usr/include/linux/rcim.h 3-3

## A

address map  
    RCIM I A-36  
    RCIM II A-21  
    RCIM III A-1  
arming interrupts 3-13, 3-19

## B

board illustration  
    RCIM I 2-13  
    RCIM II 2-8  
    RCIM III 2-2  
board specifications 1-2  
Board Status/Control Register  
    RCIM I A-37  
    RCIM II A-23  
    RCIM III A-3

## C

cable clock 2-18  
cable error messages 2-7, 2-12  
Cable Interrupt Routing Registers  
    RCIM I A-40  
    RCIM II A-27  
    RCIM III A-7  
cable length calculations B-1  
cables 2-10, 2-15, 2-18–2-19  
    RCIM I 2-16  
    RCIM II 2-10  
    RCIM III 2-4

clock registers A-11, A-30, A-41  
clock synchronization 2-21, 3-3  
clocks  
    description 3-1  
    direct access 3-3  
    GPS 2-23, 3-6  
clocksource 2-20–2-21  
close system call 3-1  
configuration information 3-11  
configuration requirements 2-20  
connection modes 2-18  
connectors  
    RCIM I 2-14–2-17  
    RCIM II 2-8–2-12  
    RCIM III 2-4–2-7

## D

Debug Visibility Connector P5 (RCIM I) 2-17  
device files  
    DI 3-19  
    ETI 3-13  
    PIG 3-16  
    RTC 3-14  
device ID, see PCI vendor/device ID  
DIs  
    arming 3-19  
    configuration 2-22, 3-18  
    device files 3-19  
    disarming 3-19  
    example 3-10  
    guidelines 3-10  
    interrupt requests 3-19  
    overview 3-17  
    signal processing 3-8–3-9  
    user interface 3-19  
disarming interrupts 3-19  
distributed interrupts, *see also* DIs  
    ETIs 3-14  
    PIGs 3-17  
    RTCs 3-14

## E

edge-triggered interrupts, *see* ETIs

### ETIs

- arming 3-13
- configuration 3-12
- device files 3-13
- disarming 3-13
- distributed 3-14
- example 3-10
- interrupt requests 3-13
- overview 3-12
- signal processing 3-8–3-9
- user interface 3-13

external interrupt I/O connector

- RCIM I 2-14, 2-16–2-17
- RCIM II 2-10–2-12
- RCIM III 2-5–2-7

External Interrupt Routing Registers

- RCIM I A-39
- RCIM II A-26
- RCIM III A-6

external output signals

- configuration 3-16
- example 3-10
- overview 3-15

## F

final slave 2-18

functional description 3-1

## G

GPS 2-2, 2-5, 2-8, 2-10, 2-20, 2-23, 3-6

## H

hardware

- RCIM I 2-13
- RCIM II 2-8
- RCIM III 2-2

hardware overview 2-1

## I

initialization 2-20

input cable connector

- RCIM I 2-14, 2-16
- RCIM II 2-8, 2-10

RCIM III 2-4

installation instructions 2-19

In-System Programming Interface Connector P6 (RCIM I) 2-17

interrupt

- handling 3-8
- registers A-5, A-25, A-38

introduction 1-1

ioctl system call 3-1, 3-11

isolated mode 2-18

## L

LEDs 2-14

- RCIM I 2-14
- RCIM II 2-8–2-9
- RCIM III 2-3

## M

master mode 2-18

message signaled Interrupts (MSI) 2-22

mmap 3-11

## N

NTP 2-23, 3-6

## O

OCXO (Oven Controlled Crystal Oscillator) 2-2, 2-4, 2-8, 2-10

open system call 3-1

oscillator 2-2, 2-4, 2-8, 2-10

output cable connector

- RCIM I 2-14–2-15
- RCIM II 2-8, 2-10
- RCIM III 2-4

## P

pass-through slave 2-18

PCI vendor/device ID

- RCIM I 2-17
- RCIM II 2-7, 2-12
- RCIM III 2-7

PIGs

- device files 3-16
- distributed 3-17
- example 3-10

- overview 3-16
- registers A-16, A-35, A-44
- POSIX clock
  - GPS 2-20
  - overview 3-2
  - registers A-13, A-32, A-42
  - set time 3-3
  - synchronizing 3-5
- POSIX Clock Status/Control Register
  - RCIM I A-42
  - RCIM II A-32
  - RCIM III A-13
- programmable interrupt generators (PIGs), *see* PIGs

## R

- RCIM chain 2-18, 2-20, 3-1, 3-10, 3-17
- RCIM values 3-11
- RCIM\_CLOCKSOURCE 2-20
- rcim\_clocksync utility 3-3
- RCIM\_IRQ\_EXTENSIONS 2-20
- RCIM\_PPS 2-20
- real-time clocks (RTC), *see* RTCs
- Registers
  - RCIM I A-37
  - RCIM II A-23
  - RCIM III A-3
- registers 3-11
- related publications iv
- RTCs
  - device files 3-14
  - distributed 3-14
  - example 3-10
  - overview 3-14
  - registers A-14–A-15, A-33–A-34, A-43
  - user interface 3-15

## S

- signal processing
  - logic 3-8
  - overview 3-8
  - recognition logic 3-9
- slave modes 2-18
- synchronization cable 2-18–2-19, B-1
  - RCIM I 2-15–2-16
  - RCIM II 2-10, 2-12
  - RCIM III 2-4, 2-7
- syntax notation iii

## T

- TCXO (Temperature Compensated Crystal Oscillator)
  - 2-4
- tick clock
  - GPS 2-20
  - overview 3-2
  - registers A-11, A-30, A-41
  - synchronizing 3-5
- Tick Clock Status/Control Registers
  - RCIM I A-41
  - RCIM II A-30
  - RCIM III A-11

## U

- unpacking instructions 2-18





